

# *Grizzly* *Industrial, Inc.*®

## MODEL H6141 AIR PALM NAILER OWNER'S MANUAL



COPYRIGHT © DECEMBER, 2005 BY GRIZZLY INDUSTRIAL, INC., REVISED APRIL, 2009 (TR)  
**WARNING: NO PORTION OF THIS MANUAL MAY BE REPRODUCED IN ANY SHAPE  
OR FORM WITHOUT THE WRITTEN APPROVAL OF GRIZZLY INDUSTRIAL, INC.**  
#JK7796 PRINTED IN CHINA

# SAFETY

## **WARNING**

### **For Your Own Safety Read Instruction Manual Before Operating This Equipment**

The purpose of safety symbols is to attract your attention to possible hazardous conditions. This manual uses a series of symbols and signal words which are intended to convey the level of importance of the safety messages. The progression of symbols is described below. Remember that safety messages by themselves do not eliminate danger and are not a substitute for proper accident prevention measures.



Indicates an imminently hazardous situation which, if not avoided, WILL result in death or serious injury.



Indicates a potentially hazardous situation which, if not avoided, COULD result in death or serious injury.



Indicates a potentially hazardous situation which, if not avoided, MAY result in minor or moderate injury. It may also be used to alert against unsafe practices.

***NOTICE***

This symbol is used to alert the user to useful information about proper operation of the equipment.

## **WARNING**

### **Safety Instructions For Pneumatic Tools**

- KEEP ALL SAFETY DEVICES IN PLACE** and in working order.
- REMOVE ADJUSTING KEYS AND WRENCHES.** Form habit of checking to see that keys and adjusting wrenches are removed from tool before operation.
- DO NOT USE IN DANGEROUS ENVIRONMENT.** Do not use pneumatic tools in damp or wet locations, or where any flammable or noxious fumes may exist. Keep work area well lighted.
- KEEP CHILDREN AND VISITORS AWAY.** All children and visitors should be kept at a safe distance from work area.
- MAKE WORKSHOP CHILD PROOF** by locking your shop and shutting off air valves.
- DO NOT FORCE TOOL.** It will do the job better and safer at the rate for which it was designed.
- USE THE RIGHT TOOL.** Do not force tool or attachment to do a job for which it was not designed.

# **WARNING**

## **Safety Instructions For Pneumatic Tools**

8. **DO NOT USE UNDER THE INFLUENCE OF DRUGS OR ALCOHOL.**
9. **USE PROPER AIR HOSE** for the tool. Make sure your air hose is in good condition and is long enough to reach your work without stretching.
10. **WEAR PROPER APPAREL.** Do not wear loose clothing, gloves, neckties, rings, bracelets, or other jewelry which may get caught in moving parts. Non-slip footwear is recommended. Wear a protective hair covering to contain long hair.
11. **ALWAYS USE SAFETY GLASSES.** Also use a face or dust mask if cutting operation is dusty. Everyday eyeglasses only have impact resistant lenses, they are NOT safety glasses.
12. **WEAR APPROVED HEARING PROTECTION.** Air escaping from pneumatic tools can exceed safe exposure limits and may cause hearing damage with prolonged exposure.
13. **SECURE WORK.** Use clamps or a vise to hold work when practical. It is safer than using your hand and frees both hands to operate tool.
14. **MAINTAIN TOOLS WITH CARE.** Keep tools lubricated and clean for best and safest performance. Follow instructions for lubricating and changing accessories.
15. **DISCONNECT TOOLS** before servicing, changing accessories, or moving to another location.
16. **USE THE RECOMMENDED ACCESSORIES.** Consult owner's manual for recommended accessories. The use of improper accessories may cause risk of injury.
17. **CHECK FOR DAMAGED PARTS BEFORE USING.** Check for binding and alignment of parts, broken parts, part mounting, loose bolts, and any other conditions that may affect machine operation. Repair or replace damaged parts.
18. **NEVER LEAVE UNATTENDED TOOL CONNECTED TO AIR.** Disconnect the air hose and do not leave tool until it is relieved of any built up pressure.
19. **NEVER ALLOW UNTRAINED USERS TO USE THIS TOOL WHILE UNSUPERVISED.**
20. **IF YOU ARE UNSURE OF THE INTENDED OPERATION, STOP USING TOOL.** Seek formal training or research books or magazines that specialize in pneumatic tools.
21. **BE AWARE OF HOSE LOCATION WHEN USING PNEUMATIC TOOLS.** Hoses can easily become a tripping hazard when laid across the floor or spread out in a disorganized fashion.

# WARNING

## Additional Safety Instructions for Nailers

- 1. HAND INJURIES:** Do not place your hands near the nail point of entry. A nail can deflect and tear through the surface of the workpiece, puncturing your hand or fingers.
- 2. COMBUSTIBLE GASES:** Never connect the nailer to pressurized oxygen or other combustible gases as a power source. Only use filtered, lubricated, and regulated compressed air.
- 3. CLEANING:** Never use gasoline or other flammable liquids to clean the nailer; vapors in the nailer will ignite by a spark and cause it to explode.
- 4. OPERATING QUESTIONS:** If you are not sure about the intended operation, stop using the nailer. Seek formal training or research books or magazines that specialize in pneumatic tools.
- 5. HOSE USAGE:** Make sure your air hose is designed for the tool in use, is in good condition, and is long enough to reach your work without stretching. However, an overly long air hose in the work area may be a tripping hazard.
- 6. MAINTENANCE:** Always disconnect air from the nailer when servicing. During maintenance, a nailer connected to air may fire accidentally, causing serious personal injury.
- 7. COMPRESSED AIR RATING:** Do not connect the nailer to compressed air that exceeds 120 PSI.
- 8. CHECK VALVE:** Do not use a check valve or any other fitting that allows air to remain in the tool.



# WARNING

Operating this nailer can propel objects into the air, causing immediate eye damage. To protect yourself, always wear American National Standards Institute (ANSI) approved safety glasses or goggles when operating this equipment. In addition, this nailer discharges at up to 85-90 decibels. To protect your hearing, always wear ANSI approved ear protection when operating this nailer.

# INTRODUCTION

---

---

## Foreword

---

---

We are proud to offer the Grizzly Model H6141 Air Palm Nailer. This model is part of a growing Grizzly family of fine pneumatic tools. When used according to the guidelines set forth in this manual, you can expect years of trouble-free, enjoyable operation and proof of Grizzly's commitment to customer satisfaction.

The specifications, details, and photographs in this manual represent the Model H6141 as supplied when the manual was prepared. However, owing to Grizzly's policy of continuous improvement, changes may be made at any time with no obligation on the part of Grizzly.

---

---

## Machine Data

---

---

Nail Size ..... 6d–50d  
Air Inlet ..... ¼" NPT  
Weight ..... 8½ lbs.  
Operating Pressure ..... 70–100 PSI

---

---

## Contact Info

---

---

If you have any comments regarding this manual, please write to us at the following address:

Grizzly Industrial, Inc.  
C/O Technical Documentation Manager  
P.O. Box 2069  
Bellingham, WA 98227-2069

Most importantly, we stand behind our tools. If you have any service questions or parts requests, please call or write us at the location listed below.

Grizzly Industrial, Inc.  
1203 Lycoming Mall Circle  
Muncy, PA 17756  
Phone: (570) 546-9663  
Fax: (800) 438-5901  
E-Mail: [techsupport@grizzly.com](mailto:techsupport@grizzly.com)  
Web Site: <http://www.grizzly.com>

**! WARNING**

**Read the manual before operation. Become familiar with this nailer, its safety instructions, and its operation before beginning any work. Serious personal injury may result if safety or operational information is not understood or followed.**

# SET UP

## Unpacking

Your Model H6141 left our warehouse in a carefully packed box. If you discover the nailer is damaged after you have signed for delivery, *please immediately call Customer Service at (570) 546-9663 for advice.*

Save the containers and all packing materials for possible inspection by the carrier or its agent. *Otherwise, filing a freight claim can be difficult.*

When you are completely satisfied with the condition of the shipment, you should inventory the equipment.

## Inventory

After you open the nailer box, you should find the following.

### Model H6141 Inventory (Figure 1)

- A. Air Palm Nailer..... 1
- B. Bottle for Oil ..... 1
- C. Leather Nailer Cover ..... 1
- D. Hex Wrench 4MM ..... 1

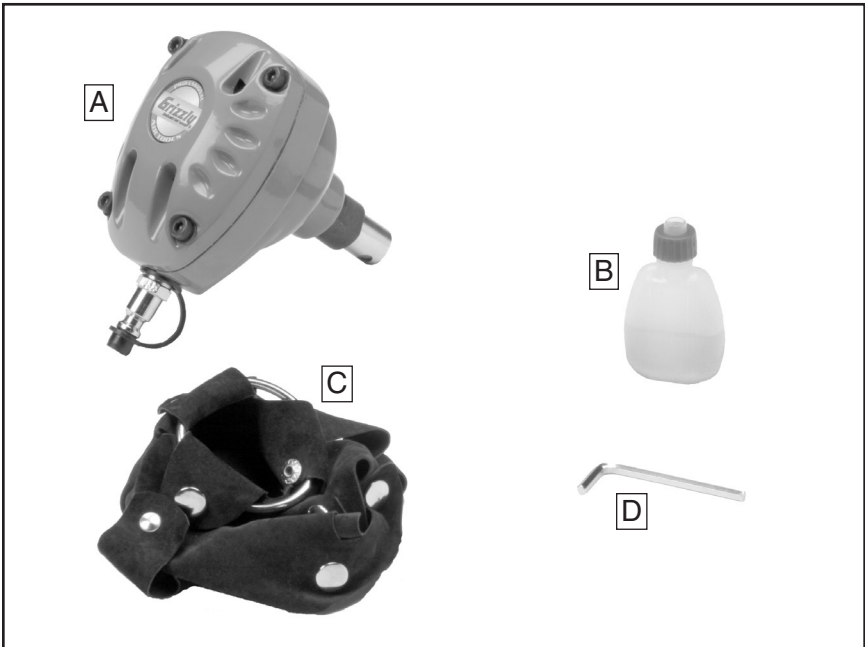

Figure 1. Model H6141 inventory.

# Compressed Air System

The Model H6141 is designed to be operated at 70-100 PSI using clean, dry, regulated, compressed air. **DO NOT exceed the 120 PSI maximum operating pressure for your model.**

Before using your new nailer, regulate the air pressure on your air compressor to the minimum PSI for your model.

An in-line filter/lubricator/regulator unit, depicted in **Figure 2**, can be installed and should be located as close to the nailer as possible.

This filter/lubricator/regulator unit will protect your tool from damaging water build-up, allow you to adjust and maintain constant air pressure to your tool, and save you the inconvenience of having to manually lubricate your tool every time you use it.

**⚠ WARNING**

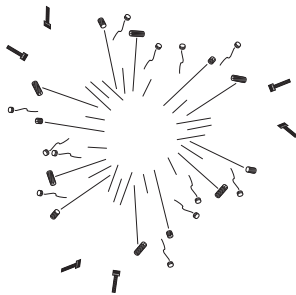

**Exceeding the maximum permissible operating pressure may cause the nailer to explode, blowing metal fragments in all directions. To protect yourself from serious personal injury, DO NOT allow your air compressor to exceed the recommended pressure when connected to this nailer!**

Check the current Grizzly catalog for availability of this unit. If you plan on installing a filter/lubricator/regulator unit in your compressed air system, always follow the connection instructions that come with the unit.

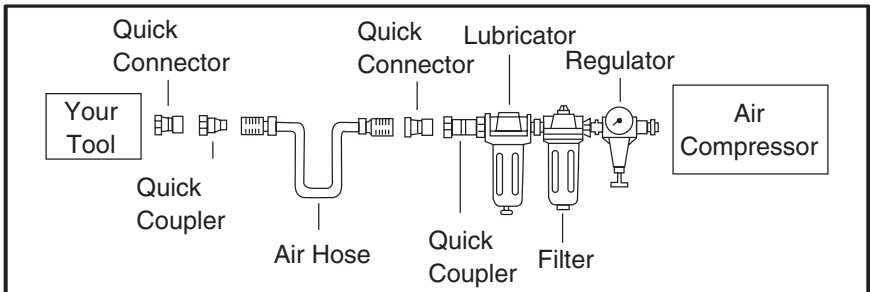

**Figure 2.** Typical filter/lubricator/regulator installation order.

# OPERATIONS

## General Operations

**If you have not read the safety instructions in this manual, do not operate the nailer.**

Before you operate your nailer, place five to six drops of pneumatic tool oil into the quick connect fitting where the nailer connects to the air supply.

### To operate your nailer:

1. Connect the air supply to the quick connect fitting.
2. Hold the nail firmly in place with one hand as if using a regular hammer.
3. Make sure you are positioned out of the way of a potential path of a nail in case of deflection.

Deflection is caused when grain irregularities, knots or foreign objects inside the wood cause the nail to change its path, resulting in the nail puncturing the surface of the workpiece, as shown in **Figure 3**.

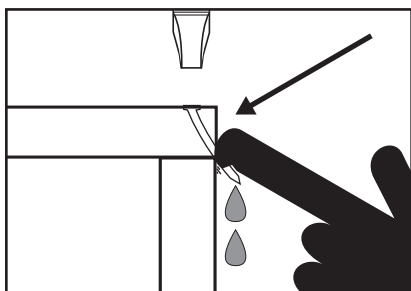
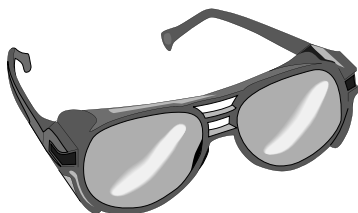

**Figure 3.** Example of nail deflection.

4. Place the tip of the palm nailer over the end of the nail. When the ram pin touches the nail head, it will automatically begin to hammer the nail into the workpiece. Hold the nailer in place until the sliding depth guide is fully depressed.
5. You can stop the nailer at any time by simply lifting it away from the nail and workpiece. This is useful if you do not wish for the nail to be countersunk into the workpiece.
5. When the nail is fully hammered into the workpiece, the nailer will automatically stop.

**Note:** *The air palm nailer will automatically countersink all nails to a depth of around 2mm or 5/64".*

## **WARNING**



**Operation of this nailer has the potential to propel debris into the air which can cause eye injury. Always wear ANSI-approved safety glasses or goggles when operating equipment.**

# Replacing Pistons/O-Rings

If you use your nailer day in and day out, replacement pistons are cheap insurance against wasted down time and lost profits, in the event that a piston or piston shaft becomes worn out.



## To replace a piston:

1. DISCONNECT NAILER FROM THE AIR SUPPLY!
2. Unscrew the nose piece with a 19mm wrench.
3. Remove the nose piece, depth guide, compression spring and flat washer.
4. Remove the four cap screws and washers on the back of the nailer.
5. Remove the cap.

6. Push the ram pin towards the inside of the nailer. This will push the cylinder free of the housing.
7. Remove the piston from the cylinder by pulling it free by the ram pin.
8. Place a new O-ring on the new piston and apply a thin film of the nailer lubricating oil on the O-ring.
9. Insert the new piston in the cylinder. The new piston should easily slide into the cylinder. **DO NOT force the piston into the cylinder!** If the piston is not easily inserted, double-check the alignment of the piston inside the cylinder.
10. After the piston is inserted correctly, place the cylinder back in the housing. If seated correctly, the cylinder will snap into place.
11. Push the cylinder collar down into the housing as far as it will go. The horizontal air slots on the side of the cylinder should be visible.
12. Replace the rear cap assembly and tighten the four cap screws.
13. Replace the flat washer, compression spring, depth guide and nose piece and tighten using a 19mm wrench.
14. For more assistance, or to install a complete O-ring set, refer to the appropriate breakdown diagram in the back of this manual for component locations.

# CLEANING & LUBRICATION

## Cleaning

Use a good solvent to clean the nose piece and depth guide of the nailer. Always be sure that the nailer is dry before using it again.

Do not allow dust, chips, sand, etc. into the air connectors or into the body of the nailer; this may result in leaks and damage to the nailer and the air couplings.

**⚠ WARNING**



**GAS**

**Never use gasoline or other flammable liquids to clean this tool. Vapors in the tool may ignite, causing the tool to explode. Ignoring this warning may lead to serious personal injury or even death!**

## Lubricating

Special oil has been included with your new Grizzly nailer to help maintain its useful life. Place two to six drops of oil in the nailer air inlet (as shown in **Figure 4**) before every use, or after 2 hours of continuous use.

Wipe off any excess oil near the nailer exhaust to avoid dust build-up. We recommend lubricating your nailer with Grizzly Model G2820 Pneumatic Tool Oil.

Another option to manual oiling would be to install a lubricator in your air compressor line. If your air compressor line already has a lubricator, then regular manual lubrication of your nailer will not be necessary. Just make sure there is always oil in the lubricator.

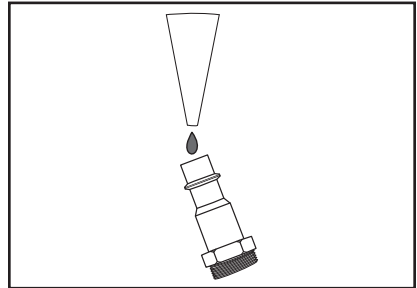

**Figure 4.** Lubricating nailer via air inlet.

# H6141 PARTS BREAKDOWN

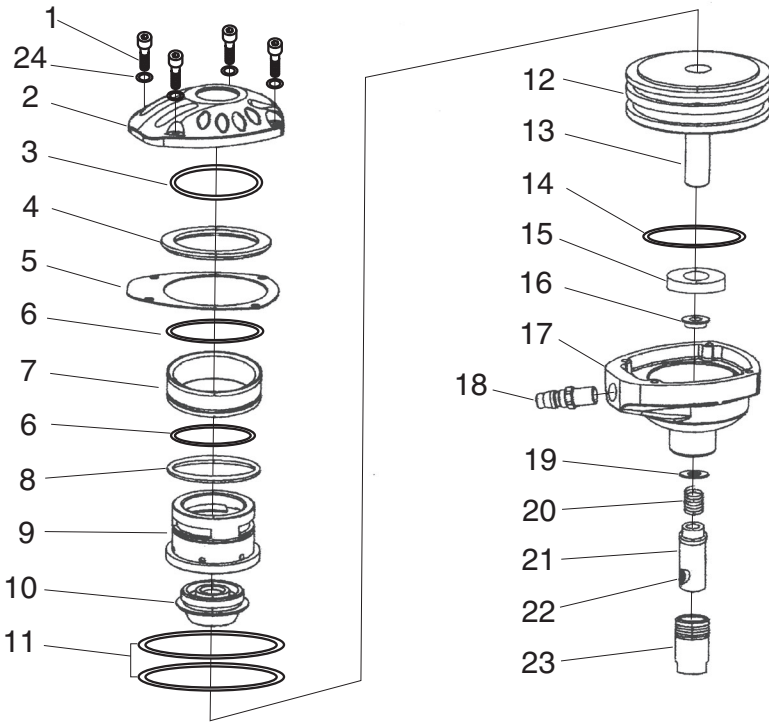

REF	PART #	DESCRIPTION
1	PSB15M	CAP SCREW M5-.8 X 20
2	PH6141002	CAP
3	PH6141003	O-RING 53.5 X 2.6
4	PH6141004	RUBBER SEAL 54MM
5	PH6141005	GASKET
6	PH6141006	O-RING 53.5 X 2.6
7	PH6141007	CYLINDER COLLAR
8	PH6141008	SEALING RING
9	PH6141009	CYLINDER
10	PH6141010	CYLINDER COVER
11	PH6141011	O-RING 43 X 2.6
12	PH6141012	PISTON

REF	PART #	DESCRIPTION
13	PH6141013	RAM PIN
14	PH6141014	O-RING 61.4 X 2.6
15	PH6141015	BUMPER 16 X 40 X 8
16	PH6141016	AXLE SLEEVE 8MM
17	PH6141017	HOUSING
18	PH6141018	AIR INLET PLUG 1/4" NPT
19	PH6141019	FLAT WASHER 9 X 20 X 1
20	PH6141020	COMPRESSION SPRING
21	PH6141021	DEPTH GUIDE
22	PH6141022	MAGNET
23	PH6141023	NOSE PIECE M20-1.5 X 37
24	PW02M	FLAT WASHER 5MM

# TROUBLESHOOTING

Symptom	Possible Cause	Possible Solution
Air leaking between housing and hose.	<ol style="list-style-type: none"> <li>1. Loose screws in housing.</li> <li>2. Damaged O-ring.</li> <li>3. Loose air fitting.</li> </ol>	<ol style="list-style-type: none"> <li>1. Tighten screws.</li> <li>2. Replace O-ring.</li> <li>3. Tighten air fitting and use teflon tape.</li> </ol>
Air leaking between housing and cap assembly.	<ol style="list-style-type: none"> <li>1. Damaged gasket.</li> </ol>	<ol style="list-style-type: none"> <li>1. Replace damaged gasket.</li> </ol>
Tool skips on nail head while discharging.	<ol style="list-style-type: none"> <li>1. Air leaks.</li> <li>2. Dirt in cylinder.</li> <li>3. Inadequate air flow to tool.</li> <li>4. Worn O-ring on piston or lack of lubrication.</li> <li>5. Gasket leaking.</li> </ol>	<ol style="list-style-type: none"> <li>1. Tighten screws and fittings.</li> <li>2. Clean cylinder and housing.</li> <li>3. Check fitting, hose, compressor and air pressure.</li> <li>4. Replace piston O-ring. Lubricate.</li> <li>5. Replace gasket.</li> </ol>
Tool drives nails too far; depth guide is loose.	<ol style="list-style-type: none"> <li>1. Broken spring.</li> <li>2. Loose nose piece.</li> </ol>	<ol style="list-style-type: none"> <li>1. Replace spring.</li> <li>2. Tighten nose piece and use teflon tape.</li> </ol>
Nailer does not fire.	<ol style="list-style-type: none"> <li>1. Piston shaft damaged.</li> <li>2. Air pressure too low.</li> </ol>	<ol style="list-style-type: none"> <li>1. Replace piston shaft.</li> <li>2. Check/increase air pressure.</li> </ol>



# WARRANTY AND RETURNS

---

Grizzly Industrial, Inc. warrants every product it sells for a period of **1 year** to the original purchaser from the date of purchase. This warranty does not apply to defects due directly or indirectly to misuse, abuse, negligence, accidents, repairs or alterations or lack of maintenance. This is Grizzly's sole written warranty and any and all warranties that may be implied by law, including any merchantability or fitness, for any particular purpose, are hereby limited to the duration of this written warranty. We do not warrant or represent that the merchandise complies with the provisions of any law or acts unless the manufacturer so warrants. In no event shall Grizzly's liability under this warranty exceed the purchase price paid for the product and any legal actions brought against Grizzly shall be tried in the State of Washington, County of Whatcom.

We shall in no event be liable for death, injuries to persons or property or for incidental, contingent, special, or consequential damages arising from the use of our products.

To take advantage of this warranty, contact us by mail or phone and give us all the details. We will then issue you a "Return Authorization Number," which must be clearly posted on the outside as well as the inside of the carton. We will not accept any item back without this number. Proof of purchase must accompany the merchandise.

The manufacturers reserve the right to change specifications at any time because they constantly strive to achieve better quality equipment. We make every effort to ensure that our products meet high quality and durability standards and we hope you never need to use this warranty.

Please feel free to write or call us if you have any questions about the machine or the manual.

**Grizzly Industrial, Inc.**  
**1203 Lycoming Mall Circle**  
**Muncy, PA 17756**  
**Phone: (570) 546-9663**  
**Fax: (800) 438-5901**

**E-Mail:**  
**techsupport@grizzly.com**

**Web Site: <http://www.grizzly.com>**

Thank you again for your business and continued support. We hope to serve you again soon!



# WARRANTY CARD

Name \_\_\_\_\_

Street \_\_\_\_\_

City \_\_\_\_\_ State \_\_\_\_\_ Zip \_\_\_\_\_

Phone # \_\_\_\_\_ Email \_\_\_\_\_ Invoice # \_\_\_\_\_

Model # \_\_\_\_\_ Order # \_\_\_\_\_ Serial # \_\_\_\_\_

*The following information is given on a voluntary basis. It will be used for marketing purposes to help us develop better products and services. **All information is strictly confidential.***

1. How did you learn about us?

Advertisement     Friend     Catalog  
 Card Deck     Website    Other: \_\_\_\_\_

2. Which of the following magazines do you subscribe to?

Cabinet Maker     Popular Mechanics     Today's Homeowner  
 Family Handyman     Popular Science     Wood  
 Hand Loader     Popular Woodworking     Wooden Boat  
 Handy     Practical Homeowner     Woodshop News  
 Home Shop Machinist     Precision Shooter     Woodsmith  
 Journal of Light Cont.     Projects in Metal     Woodwork  
 Live Steam     RC Modeler     Woodworker West  
 Model Airplane News     Rifle     Woodworker's Journal  
 Modeltec     Shop Notes     Other:  
 Old House Journal     Shotgun News

3. What is your annual household income?

\$20,000-\$29,000     \$30,000-\$39,000     \$40,000-\$49,000  
 \$50,000-\$59,000     \$60,000-\$69,000     \$70,000+

4. What is your age group?

20-29     30-39     40-49  
 50-59     60-69     70+

5. How long have you been a woodworker/metalworker?

0-2 Years     2-8 Years     8-20 Years     20+ Years

6. How many of your machines or tools are Grizzly?

0-2     3-5     6-9     10+

7. Do you think your machine represents a good value?  Yes     No

8. Would you recommend Grizzly Industrial to a friend?  Yes     No

9. Would you allow us to use your name as a reference for our customers in your area?

Note: *We never use names more than 3 times.*     Yes     No

10. Comments: \_\_\_\_\_

\_\_\_\_\_

\_\_\_\_\_

\_\_\_\_\_

Send a Grizzly Catalog to a friend:

Name _____
Street _____
City _____ State _____ Zip _____

FOLD ALONG DOTTED LINE

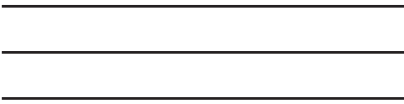

Place  
Stamp  
Here



GRIZZLY INDUSTRIAL, INC.  
P.O. BOX 2069  
BELLINGHAM, WA 98227-2069



TAPE ALONG EDGES--PLEASE DO NOT STAPLE