

Grizzly **Industrial, Inc.**®

MODEL G8749 DRUM/FLAP SANDER OWNER'S MANUAL

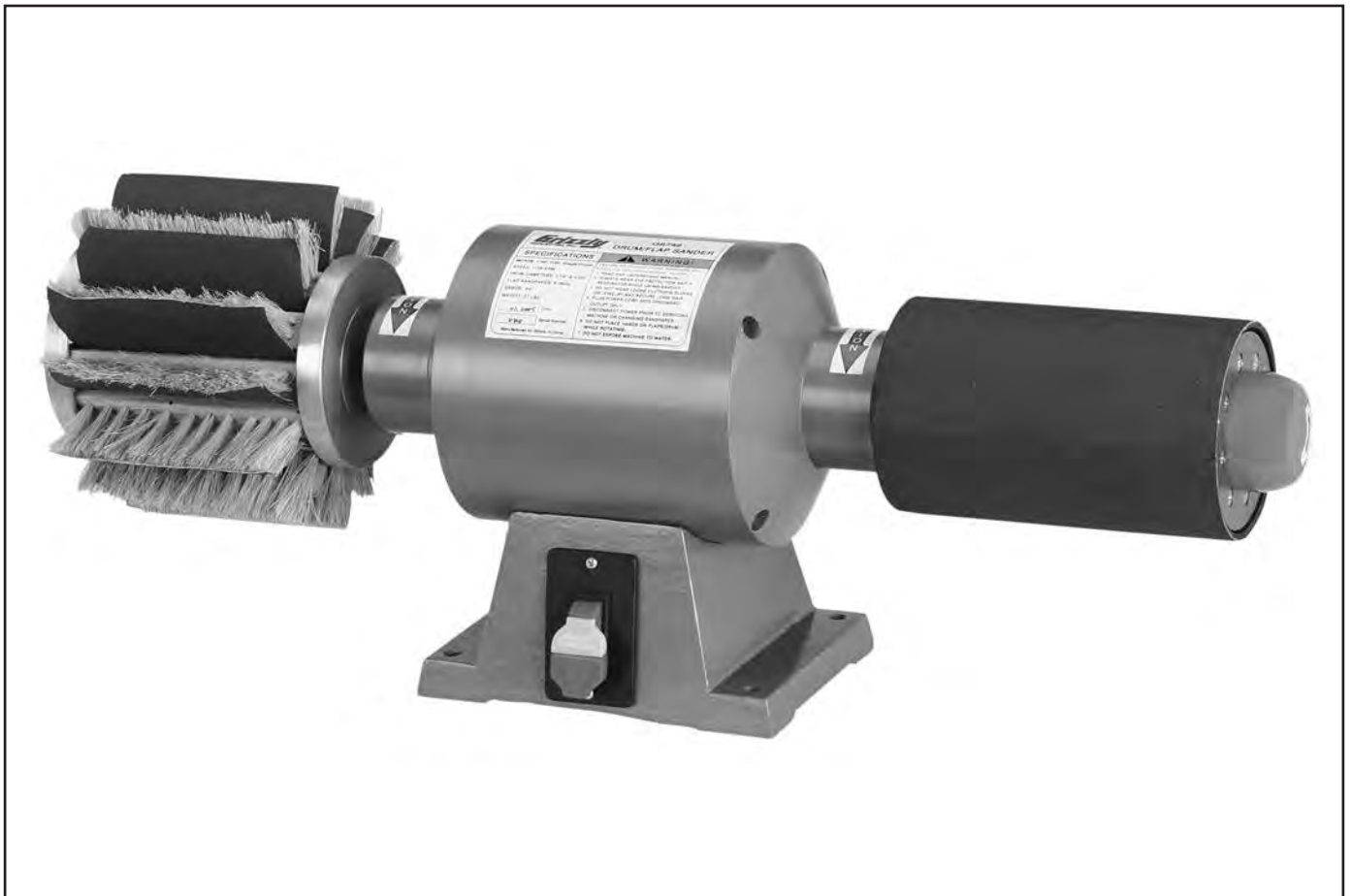

COPYRIGHT © 2000 BY GRIZZLY INDUSTRIAL, INC., REVISED SEPTEMBER, 2014 (ST)

**WARNING: NO PORTION OF THIS MANUAL MAY BE REPRODUCED IN ANY SHAPE
OR FORM WITHOUT THE WRITTEN APPROVAL OF GRIZZLY INDUSTRIAL, INC.**

#DS3216 PRINTED IN CHINA



WARNING!

This manual provides critical safety instructions on the proper setup, operation, maintenance, and service of this machine/tool. Save this document, refer to it often, and use it to instruct other operators.

Failure to read, understand and follow the instructions in this manual may result in fire or serious personal injury—including amputation, electrocution, or death.

The owner of this machine/tool is solely responsible for its safe use. This responsibility includes but is not limited to proper installation in a safe environment, personnel training and usage authorization, proper inspection and maintenance, manual availability and comprehension, application of safety devices, cutting/sanding/grinding tool integrity, and the usage of personal protective equipment.

The manufacturer will not be held liable for injury or property damage from negligence, improper training, machine modifications or misuse.



WARNING!

Some dust created by power sanding, sawing, grinding, drilling, and other construction activities contains chemicals known to the State of California to cause cancer, birth defects or other reproductive harm. Some examples of these chemicals are:

- **Lead from lead-based paints.**
- **Crystalline silica from bricks, cement and other masonry products.**
- **Arsenic and chromium from chemically-treated lumber.**

Your risk from these exposures varies, depending on how often you do this type of work. To reduce your exposure to these chemicals: Work in a well ventilated area, and work with approved safety equipment, such as those dust masks that are specially designed to filter out microscopic particles.

Table of Contents

- INTRODUCTION..... 2**
 - Manual Accuracy..... 2
 - Contact Info..... 2
 - Functional Overview..... 2
 - Identification..... 3
 - Machine Data Sheet..... 4

- SECTION 1: SAFETY 5**
 - Safety Instructions for Machinery..... 5
 - Additional Safety Instructions Sanders 7

- SECTION 2: CIRCUIT REQUIREMENTS 8**
 - 110V Operation 8

- SECTION 3: SETUP 9**
 - Setup Safety..... 9
 - Items Needed for Setup 9
 - Unpacking 9
 - Inventory..... 10
 - Site Considerations 10
 - Test Run..... 11
 - Mounting..... 12
 - Assembly..... 12

- SECTION 4: OPERATIONS 15**
 - Operation Safety 15
 - Sanding Tips 15
 - ON/OFF Switch..... 16
 - Drum Sanding 16
 - Flap Sanding 16

- SECTION 5: ACCESSORIES 17**

- SECTION 6: MAINTENANCE..... 18**
 - Schedule 18
 - Cleaning 18
 - Lubrication..... 18
 - Replacing Sanding Sleeves 18
 - Replacing Flap Sandpaper/Brushes 19

- SECTION 7: SERVICE 20**
 - Troubleshooting..... 20

- SECTION 8: WIRING..... 22**
 - Wiring Safety Instructions 22
 - Wiring Diagram..... 23

- SECTION 9: PARTS 24**
 - Parts Breakdown..... 24
 - Parts List 25

- WARRANTY AND RETURNS 29**

INTRODUCTION

Manual Accuracy

We are proud to offer this manual with your new machine! We've made every effort to be exact with the instructions, specifications, drawings, and photographs of the machine we used when writing this manual. However, sometimes errors do happen and we apologize for them.

Also, owing to our policy of continuous improvement, **your machine may not exactly match the manual.** If you find this to be the case, and the difference between the manual and machine leaves you in doubt, immediately call our technical support for updates or clarification.

For your convenience, we always keep current Grizzly manuals and most updates available on our website at www.grizzly.com. Any updates to your machine will be reflected in these documents as soon as they are complete. Visit our site often to check for the latest updates!

Contact Info

We stand behind our machines. If you have any service questions, parts requests or general questions about the machine, please call or write us at the location listed below.

Grizzly Industrial, Inc.
1203 Lycoming Mall Circle
Muncy, PA 17756
Phone: (570) 546-9663
Fax: (800) 438-5901
E-Mail: techsupport@grizzly.com

If you have any comments regarding this manual, please write to us at the address below:

Grizzly Industrial, Inc.
c/o Technical Documentation Manager
P.O. Box 2069
Bellingham, WA 98227-2069
Email: manuals@grizzly.com

Functional Overview

The Model G8749 Drum/Flap Sander is generally used for edge contour sanding using the sanding drums, as shown in **Figure 1**, or for round or spherical sanding using the flap sander, as shown in **Figure 2**.



Figure 1. Typical drum sanding operation.



Figure 2. Typical flap sanding operation.





MACHINE DATA SHEET

Customer Service #: (570) 546-9663 · To Order Call: (800) 523-4777 · Fax #: (800) 438-5901

MODEL G8749 DRUM / FLAP SANDER

Product Dimensions:

Weight..... 57 lbs.
Width (side-to-side) x Depth (front-to-back) x Height..... 30 x 7-1/2 x 10-1/2 in.
Footprint (Length x Width)..... 9 x 6-1/2 in.

Shipping Dimensions:

Type..... Cardboard Box
Content..... Machine
Weight..... 69 lbs.
Length x Width x Height..... 15 x 31 x 10 in.

Electrical:

Power Requirement..... 110V, Single-Phase, 60 Hz
Prewired Voltage..... 110V
Full-Load Current Rating..... 10A
Minimum Circuit Size..... 15A
Connection Type..... Cord & Plug
Power Cord Included..... Yes
Power Cord Length..... 5 ft.
Power Cord Gauge..... 16 AWG
Plug Included..... Yes
Included Plug Type..... 5-15
Switch Type..... Paddle Safety Switch w/Removable Key

Motors:

Main

Type..... TEFC Capacitor-Start Induction
Horsepower..... 1 HP
Phase..... Single-Phase
Amps..... 10A
Speed..... 1725 RPM
Power Transfer..... Direct Drive
Bearings..... Shielded & Permanently Lubricated

Other Specifications:

Country of Origin..... China
Warranty..... 1 Year
Approximate Assembly & Setup Time..... 30 Minutes
Serial Number Location..... ID Label on Front of Top Cover
ISO 9001 Factory..... No
CSA, ETL, or UL Certified/Listed..... No

Features:

Flap Sander Supplied with 120 Grit Paper
Includes 3-1/4" and 4-3/4" Inflatable Sanding Drums
Toggle On/Off Switch with Safety Lock



SECTION 1: SAFETY

WARNING

For Your Own Safety, Read Instruction Manual Before Operating this Machine

The purpose of safety symbols is to attract your attention to possible hazardous conditions. This manual uses a series of symbols and signal words intended to convey the level of importance of the safety messages. The progression of symbols is described below. Remember that safety messages by themselves do not eliminate danger and are not a substitute for proper accident prevention measures.



Indicates an imminently hazardous situation which, if not avoided, **WILL** result in death or serious injury.



Indicates a potentially hazardous situation which, if not avoided, **COULD** result in death or serious injury.



Indicates a potentially hazardous situation which, if not avoided, **MAY** result in minor or moderate injury. It may also be used to alert against unsafe practices.

NOTICE

This symbol is used to alert the user to useful information about proper operation of the machine.

WARNING

Safety Instructions for Machinery

OWNER'S MANUAL. Read and understand this owner's manual **BEFORE** using machine. Untrained users can be seriously hurt.

EYE PROTECTION. Always wear ANSI-approved safety glasses or a face shield when operating or observing machinery. to reduce the risk of eye injury or blindness from flying particles Everyday eyeglasses are not approved safety glasses.

HAZARDOUS DUST. Dust created while using machinery may cause cancer, birth defects, or long-term respiratory damage. Be aware of dust hazards associated with each workpiece material, and always wear a NIOSH-approved respirator to reduce your risk.

WEARING PROPER APPAREL. Do not wear clothing, apparel, or jewelry that can become entangled in moving parts. Always tie back or cover long hair. Wear non-slip footwear to avoid accidental slips which could cause a loss of workpiece control.

HEARING PROTECTION. Always wear hearing protection when operating or observing loud machinery. Extended exposure to this noise without hearing protection can cause permanent hearing loss.

MENTAL ALERTNESS. Be mentally alert when running machinery. Never operate under the influence of drugs or alcohol, when tired, or when distracted.



WARNING

Safety Instructions for Machinery

DISCONNECTING POWER SUPPLY. Always disconnect machine from power supply before servicing, adjusting, or changing cutting tools (bits, blades, cutters, etc.). Make sure switch is in OFF position before reconnecting to avoid an unexpected or unintentional start.

INTENDED USE. Only use the machine for its intended purpose and only use recommended accessories. Never stand on machine, modify it for an alternative use, or outfit it with non-approved accessories.

STABLE MACHINE. Unexpected movement during operations greatly increases the risk of injury and loss of control. Verify machines are stable/secure and mobile bases (if used) are locked before starting.

FORCING MACHINERY. Do not force machine. It will do the job safer and better at the rate for which it was designed.

GUARDS & COVERS. Guards and covers can protect you from accidental contact with moving parts or flying debris. Make sure they are properly installed, undamaged, and working correctly before using machine.

REMOVING TOOLS. Never leave adjustment tools, chuck keys, wrenches, etc. in or on machine—especially near moving parts. Verify removal before starting!

AWKWARD POSITIONS. Keep proper footing and balance at all times when operating machine. Do not overreach! Avoid awkward hand positions that make workpiece control difficult or increase the risk of accidental injury.

DANGEROUS ENVIRONMENTS. Do not use machinery in wet locations, cluttered areas, around flammables, or in poorly-lit areas. Keep work area clean, dry, and well lighted to minimize risk of injury.

APPROVED OPERATION. Untrained operators can be seriously hurt by machinery. Only allow trained or properly supervised people to use machine. When machine is not being used, disconnect power, remove switch keys, or lock-out machine to prevent unauthorized use—especially around children. Make workshop kid proof!

CHILDREN & BYSTANDERS. Keep children and bystanders a safe distance away from work area. Stop using machine if children or bystanders become a distraction.

FEED DIRECTION. Unless otherwise noted, feed work against the rotation of blades or cutters. Feeding in the same direction of rotation may pull your hand into the cut.

SECURING WORKPIECE. When required, use clamps or vises to secure workpiece. A secured workpiece protects hands and frees both of them to operate the machine.

UNATTENDED OPERATION. Never leave machine running while unattended. Turn machine **OFF** and ensure all moving parts completely stop before walking away.

MAINTENANCE & INSPECTION. A machine that is not properly maintained may operate unpredictably. Follow all maintenance instructions and lubrication schedules to keep machine in good working condition. Regularly inspect machine for loose bolts, alignment of critical parts, binding, or any other conditions that may affect safe operation. Always repair or replace damaged or mis-adjusted parts before operating machine.

EXPERIENCING DIFFICULTIES. If at any time you are experiencing difficulties performing the intended operation, stop using the machine! Contact our Technical Support Department at (570) 546-9663.



WARNING

Additional Safety Instructions Sanders

- 1. FEEDING WORKPIECE.** To avoid the risk of your hands being pulled into the machine, do not jam workpiece into the sanding attachment during operation. Firmly grasp the workpiece in both hands and ease it into the machine using light pressure.
- 2. ENTANGLEMENT HAZARD.** To avoid entanglement injuries, do not wear loose clothing, jewelry, or gloves when using this machine. Roll up long sleeves and tie back long hair.
- 3. HAND PROTECTION.** Do not place your hands near or in contact with the sanding attachments during operation. Never put your hands or fingers between the workpiece and the sander during operation.
- 4. INSPECTING WORKPIECES.** Always inspect the workpiece for nails, staples, knots, and other imperfections that could be dislodged and thrown from the machine during operation, which could cause serious personal injury.
- 5. PROTECTIVE EQUIPMENT.** Dust and chips become airborne at a high rate of speed during operation, becoming hazards to eyes and lungs. Always wear ANSI approved safety glasses or a face shield and a respirator when using this sander.
- 6. ROTATION DIRECTION.** To avoid entanglement injuries, always be aware of the rotation direction of the sanding attachments.
- 7. UNATTENDED OPERATION.** To avoid the risk of unauthorized use or accidental contact with the sanding attachments, never leave the machine running unattended. Turn the machine **OFF** after every use and remove the switch disabling key.
- 8. ADJUSTMENT, MAINTENANCE, AND SERVICE.** Perform machine inspections and maintenance service promptly and when needed. Always disconnect the machine from power when performing adjustments, maintenance, or service to avoid injuries from accidental start-up or electrocution.
- 9. SANDING ATTACHMENTS.** Always make sure the sanding attachments are correctly mounted and secure before turning the machine on. Keep these components in good working order.
- 10. EXPERIENCING DIFFICULTIES.** If at any time you are experiencing difficulties performing the intended operation, stop using the machine and contact Tech Support at (570) 546-9663.

WARNING

Like all machinery there is potential danger when operating this machine. Accidents are frequently caused by lack of familiarity or failure to pay attention. Use this machine with respect and caution to decrease the risk of operator injury. If normal safety precautions are overlooked or ignored, serious personal injury may occur.

CAUTION

No list of safety guidelines can be complete. Every shop environment is different. Always consider safety first, as it applies to your individual working conditions. Use this and other machinery with caution and respect. Failure to do so could result in serious personal injury, damage to equipment, or poor work results.



SECTION 2: CIRCUIT REQUIREMENTS

110V Operation

⚠️ WARNING

Serious personal injury could occur if you connect the machine to power before completing the setup process. **DO NOT** connect the machine to the power until instructed later in this manual.

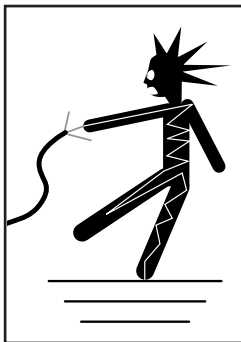

⚠️ WARNING

Electrocution or fire could result if machine is not grounded and installed in compliance with electrical codes. Compliance **MUST** be verified by a qualified electrician!

Full Load Amperage Draw

This machine draws the following amps under maximum load:

Amp Draw..... 10 Amps

Power Supply Circuit Requirements

You **MUST** connect your machine to a grounded circuit that is rated for the amperage given below. Never replace a circuit breaker on an existing circuit with one of higher amperage without consulting a qualified electrician to ensure compliance with wiring codes. **If you are unsure about the wiring codes in your area or you plan to connect your machine to a shared circuit, consult a qualified electrician.**

Minimum Circuit Size..... 15 Amps

Power Connection Device

The Model G8749 comes with a 5-15 plug, similar to **Figure 4**, to connect the machine to power.

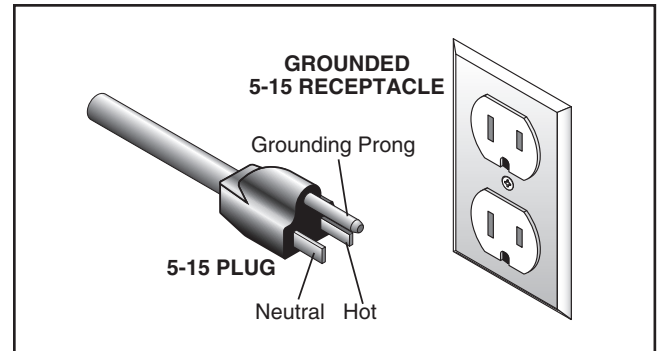
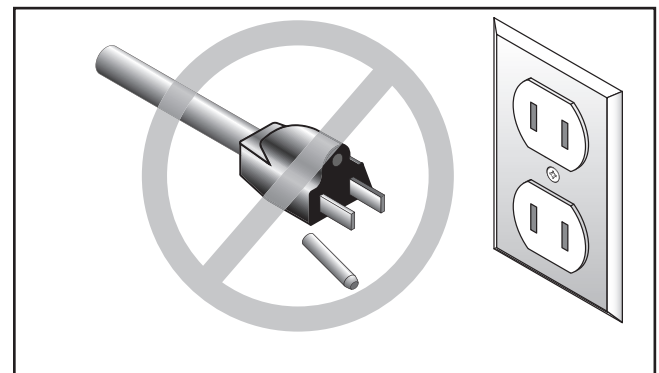

Figure 4. Typical 5-15 plug and receptacle.



⚠️ CAUTION

This machine **MUST** have a ground prong in the plug to help ensure that it is grounded. **DO NOT** remove ground prong from plug to fit into a two-pronged outlet! If the plug will not fit the outlet, have the proper outlet installed by a qualified electrician.

Extension Cords

We do not recommend using extension cords, but if you find it absolutely necessary:

- Use at least a 14 gauge cord that does not exceed 50 feet in length!
- The extension cord must have a ground wire and plug pin.
- A qualified electrician **MUST** size cords over 50 feet long to prevent motor damage.



SECTION 3: SETUP

Setup Safety

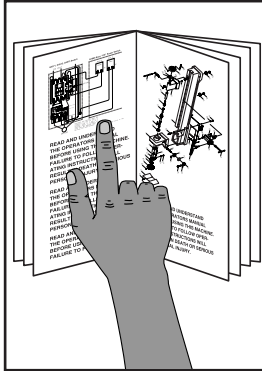

! WARNING
This machine presents serious injury hazards to untrained users. Read through this entire manual to become familiar with the controls and operations before starting the machine!



! WARNING
Wear safety glasses during the entire setup process!

Items Needed for Setup

The following items are needed to complete the setup process, but are not included with your machine:

Description	Qty
• Wrenches 14, 19mm.....	1 Each
• Mounting Hardware (Page 11) ...	As Needed

Unpacking

Your machine was carefully packaged for safe transportation. Remove the packaging materials from around your machine and inspect it. If you discover the machine is damaged, *please immediately call Customer Service at (570) 546-9663 for advice.*

Save the containers and all packing materials for possible inspection by the carrier or its agent. *Otherwise, filing a freight claim can be difficult.*

When you are completely satisfied with the condition of your shipment, inventory the contents.



Inventory

The following is a description of the main components shipped with your machine. Lay the components out to inventory them.

Note: *If you can't find an item on this list, check the mounting location on the machine or examine the packaging materials carefully. Occasionally we pre-install certain components for shipping purposes.*

Component Inventory: (Figure 5)	Qty
A. Sanding Drum 3¼" x 8".....	1
B. Flap Sander.....	1
C. Sanding Drum 4¾" x 8".....	1
D. Arbor Bolt & Flat Washer (LH)	1 Each
E. Arbor Bolt & Flat Washer (RH).....	1 Each
F. Flap Sander Arbor Bolt & Flange	1 Each
G. End Caps.....	2

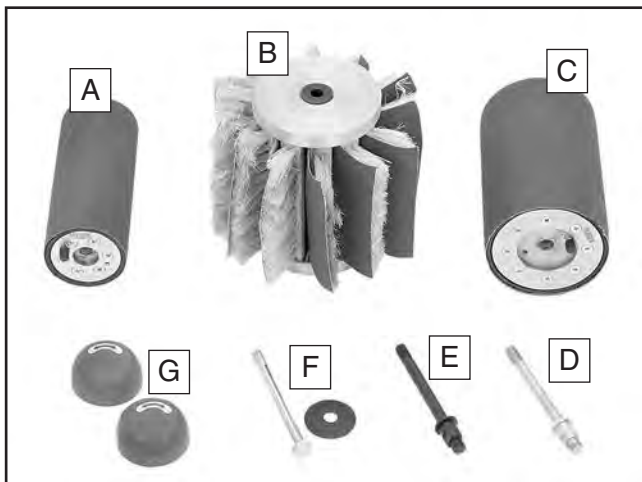
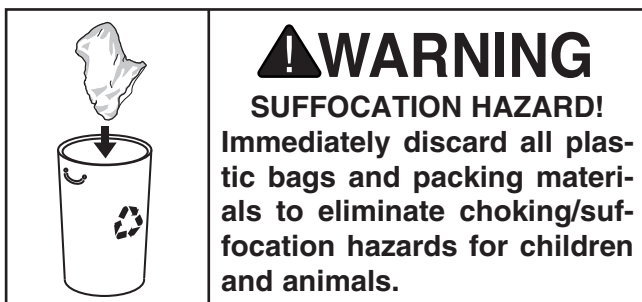

Figure 5. Model G8749 inventory.

If any nonproprietary parts are missing (e.g. a nut or a washer), we will gladly replace them; or for the sake of expediency, replacements can be obtained at your local hardware store.



Site Considerations

Workbench Load

Refer to the **Machine Data Sheet** for the weight and footprint specifications of your machine. Some workbenches may require additional reinforcement to safely support the machine.

Placement Location

Consider existing and anticipated needs, size of material to be processed through each machine, and space for auxiliary stands, work tables or other machinery when establishing a location for your new machine. See **Figure 6** for the minimum working clearances.

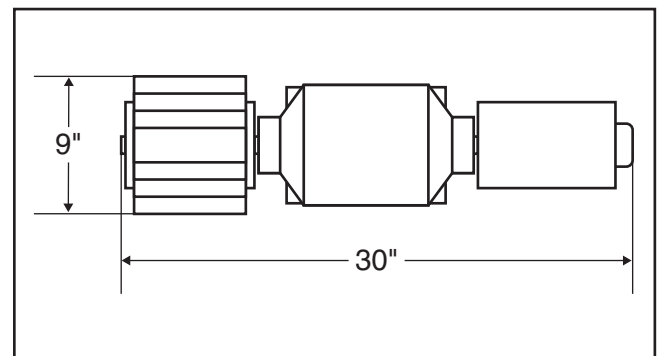
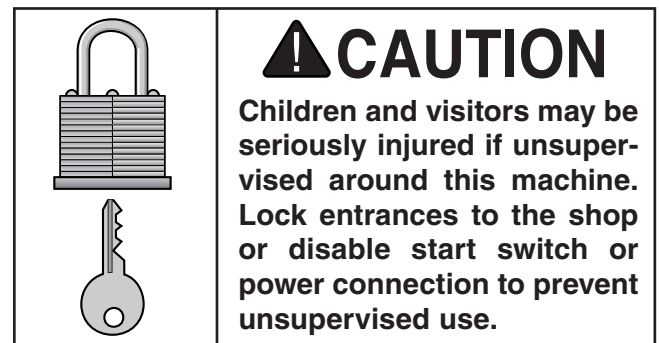

Figure 6. Minimum working clearances.



Mounting

Due to the significant forces exerted on the sander during operation, you must mount it to a workbench. We recommend that you use one of the following methods to secure your sander to the workbench before using it.

The strongest mounting option is a "Through Mount" where holes are drilled all the way through the workbench, and hex bolts, washers, and hex nuts are used to secure the sander to the workbench.

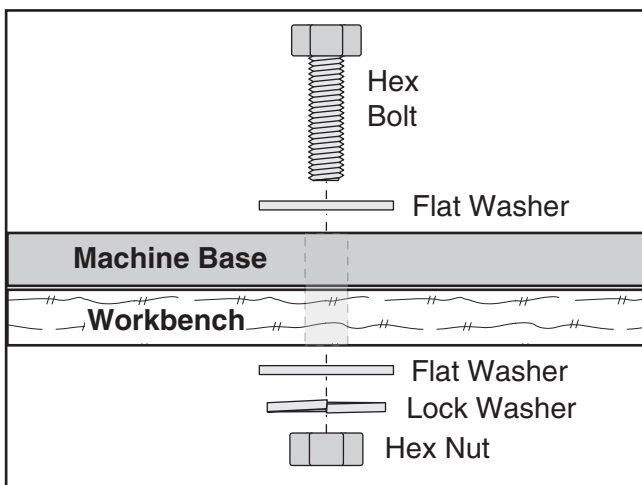

Figure 7. Example of a through mount setup.

Another option for mounting is a "Direct Mount" where the machine is simply secured to the workbench with a lag screw.

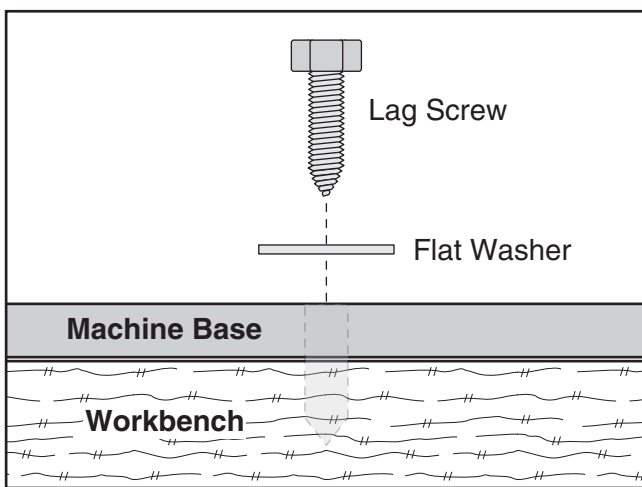

Figure 8. Example of a direct mount setup.

Test Run

Once the assembly is complete, test run your machine to make sure it runs properly and is ready for regular operation.

The test run consists of verifying the following: 1) The motor powers up and runs correctly, and 2) the safety disabling mechanism works correctly.

If, during the test run, you cannot easily locate the source of an unusual noise or vibration, stop using the machine immediately, then review **Troubleshooting on Page 20**.

If you still cannot remedy a problem, contact our Tech Support at (570) 546-9663 for assistance.

To test run the machine:

1. Make sure you have read the safety instructions at the beginning of the manual and that the machine is set up properly.
2. Make sure all tools and objects used during setup are cleared away from the machine.
3. Connect the machine to the power source.
4. Verify that the machine is operating correctly by turning the it **ON**.

—When operating correctly, the machine runs smoothly with little or no vibration or rubbing noises.

—Investigate and correct strange or unusual noises or vibrations before operating the machine further. Always disconnect the machine from power when investigating or correcting potential problems.

Continued on next page →



5. Turn the machine **OFF**.
6. Remove the switch disabling key, as shown in **Figure 9**.

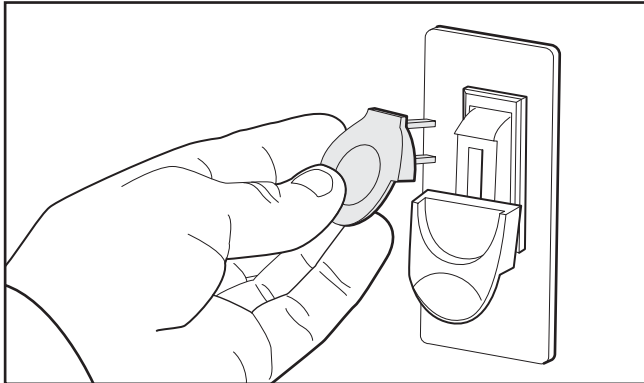

Figure 9. Removing switch key from paddle switch.

7. Try to start the machine by flipping the paddle switch up to the ON position.
 - If the machine does not start, the switch disabling feature is working as designed.
 - If the machine starts, immediately stop it. The switch disabling feature is not working correctly. This safety feature must work properly before proceeding with regular operations. Call Tech Support for help.

Assembly

The flap sander is designed to be mounted only on the left side of the machine, whereas the drum sanders can be mounted on either side.

Attaching Flap Sander

1. DISCONNECT SANDER FROM POWER!
2. When removed from the shipping box, the flap sander is held together by two tie wraps. Hold the assembly together from top to bottom, then remove the ties and store them for future use.

Note: If the brushes should come loose from the end plates during this step, refer to **Replacing Flap Sandpaper/Brushes** on **Page 19** for detailed instructions on how to put the assembly back together.
3. Position the flap sander so the sanding surface of the paper is facing you, then carefully slide it onto the left hand arbor, as shown in **Figure 10**.

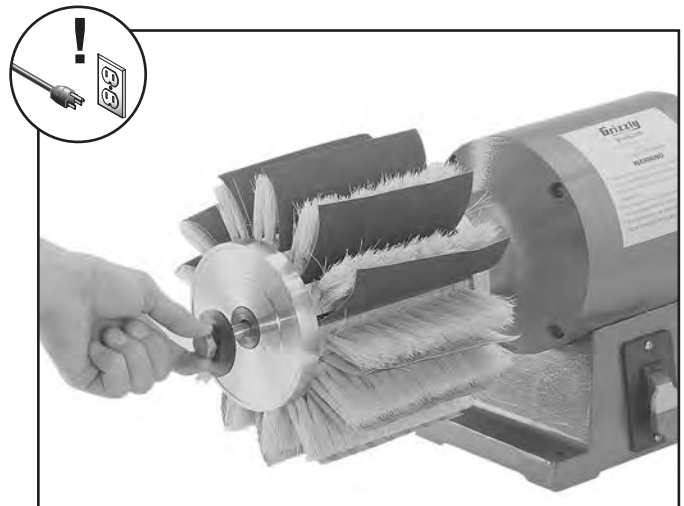

Figure 10. Installing flap sander.

4. Secure the flap sander by threading the flap sander arbor bolt and flange into the spindle, as shown in **Figure 10**. Make sure to fully tighten the bolt.

Note: This arbor bolt has left-hand threads and tightens by rotating it counterclockwise.



Reversing Sleeve Rotation

The sanding drums are shipped with 120 grit sanding sleeves already installed. The sleeve rotations are configured so that the large diameter drum is mounted on the right side of the sander and the smaller drum is mounted on the left.

If you want to change the mounting location of the drums from the positions above, you must remove the sanding sleeve and turn it around so that the sleeve rotation matches the spindle rotation.

To reverse the sleeve rotation:

1. DISCONNECT SANDER FROM POWER!
2. Remove the protective cap on the air valve, then push the valve stem to release all of the air pressure from the drum (see **Figure 11**).

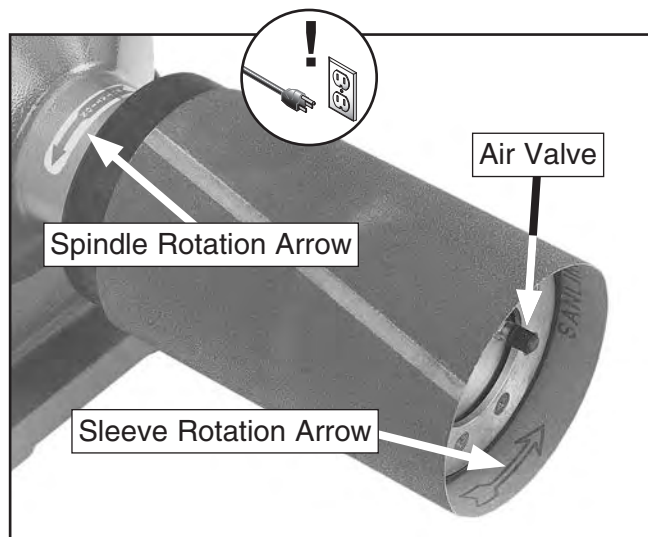
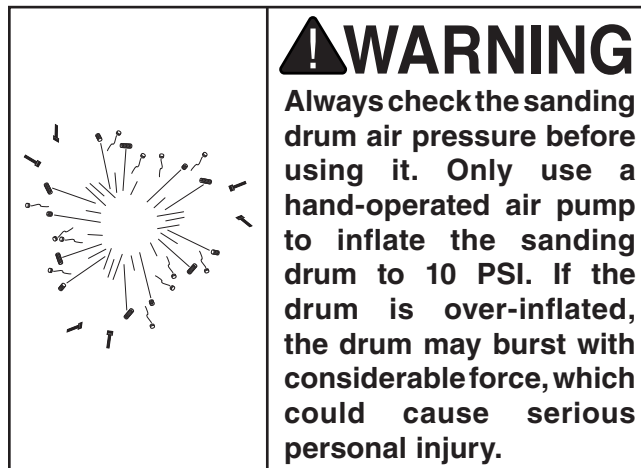

Figure 11. Matching the sleeve rotation with the spindle rotation.

3. Remove the sleeve from the drum, turn it around, then slide it back onto the drum.
4. Hold the mounted sleeve up to the spindle that you will be installing them on, then make sure the sleeve rotation arrows and the rotation arrow on the spindle housing match.



Mounting Sanding Drum

It is important that the air pressure of the sanding drum be maintained at 10 PSI to safely hold the sanding sleeve in place.

To check air pressure and mount the sanding drum:

1. DISCONNECT SANDER FROM POWER!
2. Remove the air valve protective cap, then use a quality air pressure gauge to check the drum air pressure, as shown in **Figure 12**.
 - If the drum air pressure is more than 10 PSI, push the valve stem in to reduce the air pressure. Use the gauge to recheck the pressure.
 - If the drum air pressure is less than 10 PSI, use a hand-operated air pump to inflate the sanding drum to 10 PSI.



Figure 12. Checking sanding drum air pressure.



3. Replace the valve protective cap.
4. Slide the drum onto the spindle with the air valve facing out, then secure it by threading the arbor bolt with a flat washer through the drum and into the spindle, as shown in **Figure 13**. Make sure to fully tighten the bolt.

Note: *The left spindle uses the arbor bolt with left-hand threads, which tightens by rotating it counterclockwise. The right spindle arbor bolt has right-hand threads and tightens by rotating it clockwise.*

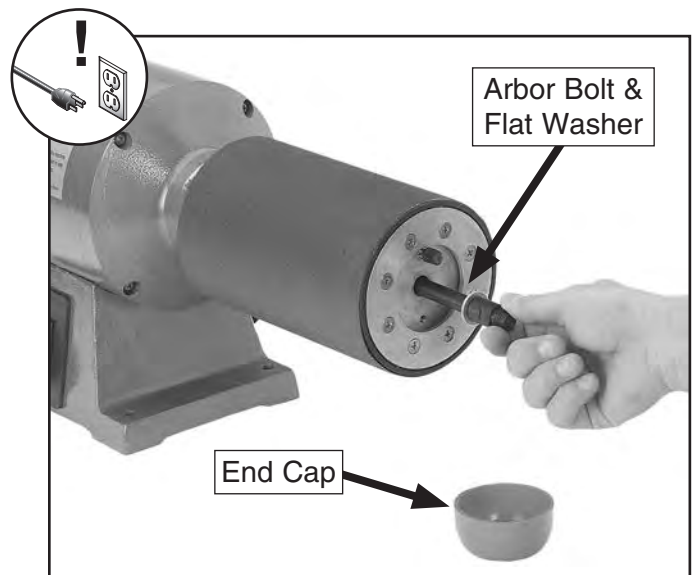

Figure 13. Installing the sanding drum.

5. Fully thread the end cap onto the arbor bolt to protect the valve stem during operation.

Note: *One end cap also has left-hand threads and is mounted on the left side of the machine. The other cap has right-hand threads for the right side of the machine.*



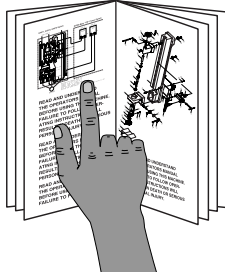

SECTION 4: OPERATIONS

Operation Safety

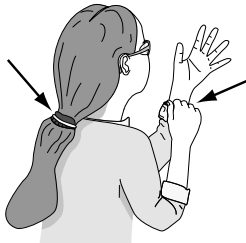
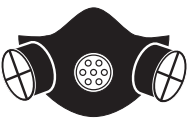

!WARNING
To reduce the risk of serious injury when using this machine, read and understand this entire manual before beginning any operations.

!WARNING
Damage to your eyes and lungs could result from using this machine without proper protective gear. Always wear safety glasses and a respirator when operating this machine.



!WARNING
Loose hair, clothing, or jewelry could get caught in machinery and cause serious personal injury. Keep these items away from moving parts at all times to reduce this risk.

NOTICE

If you have never used this type of machine or equipment before, WE STRONGLY RECOMMEND that you read books, trade magazines, or get formal training before beginning any projects. Regardless of the content in this section, Grizzly Industrial will not be held liable for accidents caused by lack of training.

Sanding Tips

Your sander is a safe tool when used properly. In addition to the safety instructions in this manual, the most important safety consideration is to use common sense at all times.

Follow these rules when sanding:

- Make sure the sanding attachments are properly installed and the spindle rotation of the sandpaper and spindle match.
- Use both hands and engage the workpiece with the spinning drum or flap sander slowly and firmly. There can be considerable force generated by the rotating device, causing the workpiece to fly out of your hands.
- Check the sanding drum air pressure before each use. Maintain the air pressure at 10 PSI. Do not over-inflate the drums.
- Always turn the sander **ON** and allow it to reach full speed before engaging the workpiece with the sandpaper.
- Use the correct sandpaper and grit for the job to ensure good sanding results.
- Do not use the sander as a replacement for a bandsaw or a planer. It is designed for finish work, not rough dimensioning.
- Keep your workpiece moving across the face of the drum or flap sander to prevent grooves or ruts in the workpiece surface.



ON/OFF Switch

This machine has a special safety ON/OFF paddle switch with a removable switch disabling key, as shown in **Figure 14**.

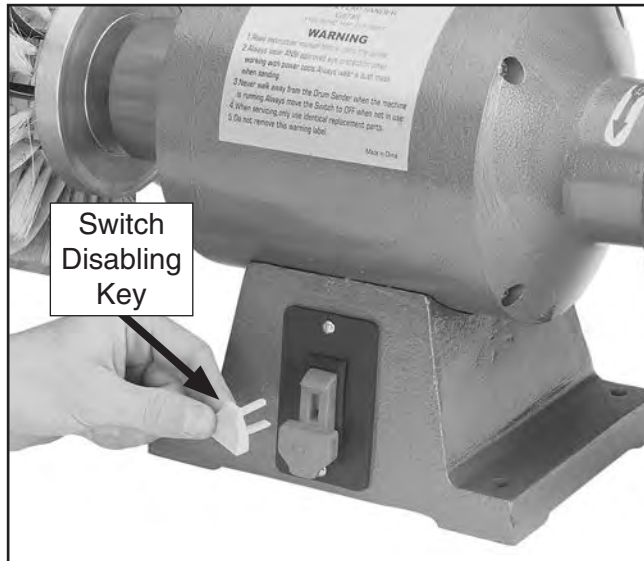

Figure 14. Removing the ON/OFF switch disabling key.

Turn the machine **OFF**, then remove the disabling key when leaving the machine to prevent accidental or unauthorized start-up.

If the key is removed while the machine is running, the sander can still be turned **OFF**. However, you need to re-install the key before turning the sander back **ON**.

Drum Sanding

Drum sanding is perfect for performing sanding operations on edge contours.

Use a soft sanding sleeve when sanding contours with rounded or soft edges. A hard sleeve is desirable when the sanded edge is to be sharp.

Make sure the sanding sleeve is mounted on the drum and sander so that the sleeve rotation and spindle rotation match. The spindle will always rotate toward the operator.

Figure 15 shows a typical drum sanding operation.

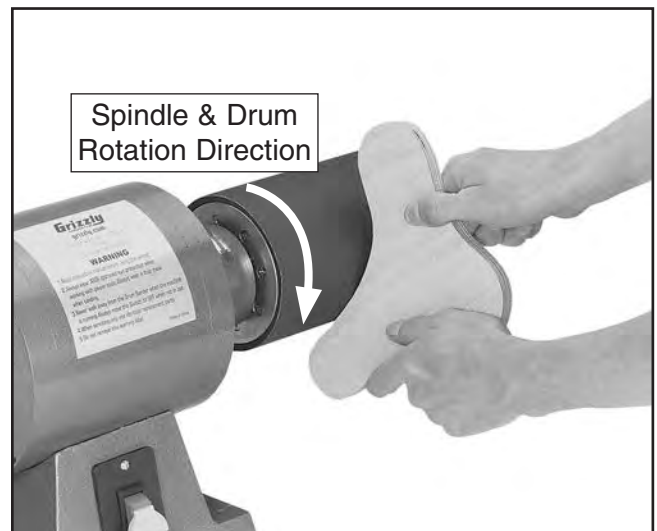

Figure 15. Typical drum sanding operation.

Flap Sanding

Flap sanding is useful for sanding rounded or spherical shapes. With the flap sander mounted on the left hand spindle, the abrasive side of the sanding flaps will rotate toward the operator. It is generally best to introduce the workpiece to the bottom of the flap sander, as shown in **Figure 16**, for the best control of the sanding forces.

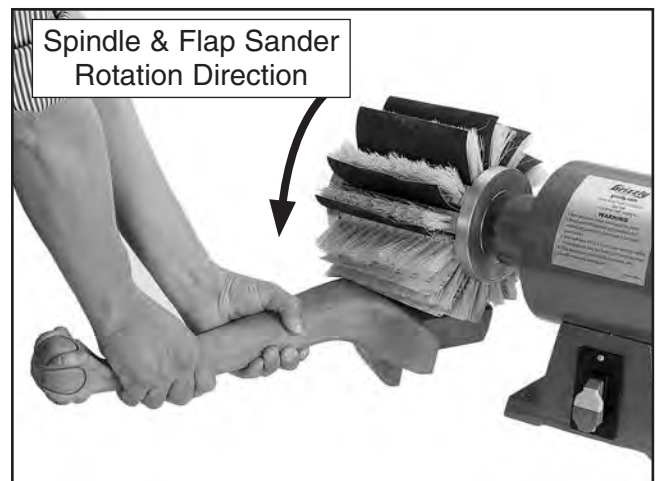

Figure 16. Typical flap sanding operation.



SECTION 5: ACCESSORIES

G9956—Remote Controlled Heavy-Duty Hanging Air Filter

Set the duration and speed with the remote control from as far away as 45 feet, then hold on as the fan spools up to draw a massive 1400 CFM through the 1 micron filter. Changes the air in a 20' x 20' x 8' room 26 times an hour. Hangs easily from the ceiling. A three pocket internal filter bag simplifies cleaning. Motor is 1/3 HP, 110V, 3 amp. Dimensions: 30 1/8"L x 19 7/8"W x 16 3/8"H and weighs 74 lbs.

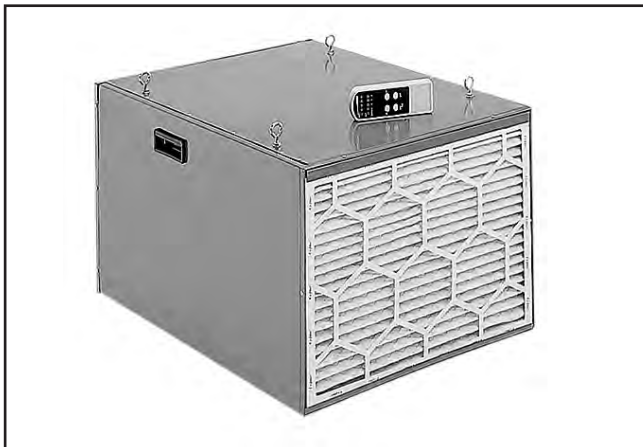

Figure 17. Model G9956 Hanging Air Filter.

Aluminum Oxide Sanding Sleeves

- G9196—3 1/4" Diameter, 60 Grit
- G9197—3 1/4" Diameter, 80 Grit
- G9198—3 1/4" Diameter, 100 Grit
- G9199—3 1/4" Diameter, 120 Grit
- G9200—3 1/4" Diameter, 150 Grit
- G9201—3 1/4" Diameter, 180 Grit
- G9208—4 3/4" Diameter, 60 Grit
- G9209—4 3/4" Diameter, 80 Grit
- G9210—4 3/4" Diameter, 100 Grit
- G9211—4 3/4" Diameter, 120 Grit
- G9212—4 3/4" Diameter, 150 Grit
- G9213—4 3/4" Diameter, 180 Grit

6" x 60" J Weight Aluminum Oxide Rolls for Flap Sander

- G9187—120 Grit
- G9188—180 Grit
- G9189—220 Grit

H2491—Replacement Flap Brushes, Set of 12

G8749 Drum/Flap Sander

T20514—Small Half-Mask Respirator

T20515—Medium Half-Mask Respirator

T20516—Large Half-Mask Respirator

Wood and other types of dust can cause severe respiratory damage. If you work around dust every-day, a half-mask respirator can greatly reduce your risk. Compatible with safety glasses!



Figure 18. Half-mask respirator with disposable cartridge filters.

T20501—Face Shield Crown Protector 4"

T20502—Face Shield Crown Protector 7"

T20503—Face Shield Window

T20448—Economy Clear Safety Glasses

T20452—"Kirova" Anti-Reflective Glasses

T20456—"Dakura" Clear Safety Glasses

H0736—Shop Fox® Safety Glasses

These glasses meet ANSI Z87.1-2003 specifications. Buy extras for visitors or employees. You can't be too careful with shop safety!

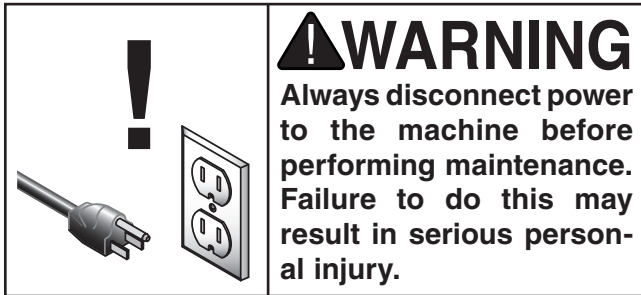

Figure 19. Our most popular eye protection.

Call 1-800-523-4777 To Order



SECTION 6: MAINTENANCE



Schedule

For optimum performance from your machine, follow this maintenance schedule and refer to any specific instructions given in this section.

Daily Check:

- Loose mounting bolts.
- Damaged or worn sandpaper/brushes.
- Sanding drum air pressure.
- Worn or damaged wires.
- Any other unsafe condition.

Daily Maintenance:

- Clean machine.

Cleaning

Cleaning the Model G8749 is relatively easy. Vacuum excess wood chips and sawdust, and wipe off the remaining dust with a dry cloth. If any resin has built up, use a resin dissolving cleaner to remove it.

Lubrication

Bearings are sealed and permanently lubricated, so simply leave them alone unless they need replacement.

Replacing Sanding Sleeves

Your sander is supplied with a large 4 $\frac{3}{4}$ " x 8" sanding drum and a smaller 3 $\frac{1}{4}$ " x 8" drum. Both drums will accept soft or hard sanding sleeves.

To replace the sanding sleeve:

1. DISCONNECT SANDER FROM POWER!
2. Remove the air valve protective cap, press the valve stem to release the drum air pressure (see **Figure 20**), then slide the sleeve off the drum.

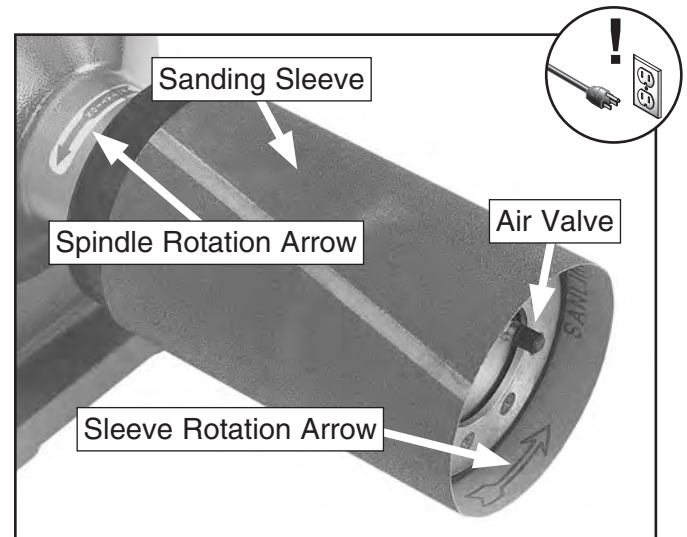

Figure 20. Replacing sanding sleeve.

3. Match the direction of the sleeve rotation arrow with the spindle rotation arrow, then slide the replacement sleeve onto the drum.

Note: Make sure the sanding sleeve does not extend beyond either end of the drum.

4. Use a hand-operated air pump to inflate the sanding drum to 10 PSI, then replace the valve cap.



Replacing Flap Sandpaper/Brushes

To replace the flap sandpaper or brushes:

1. DISCONNECT SANDER FROM POWER!
2. While holding the outside end plate of the flap sander, remove the arbor bolt and flange, then remove the flap sander and place it upright on a flat surface.
3. Remove the top end plate, then remove one or two brushes to gain access to the retaining bars that secure the sandpaper.

Note: All of the replacement sandpaper needs to be oriented and installed so that the abrasive side faces the same direction and will face forward and down when the flap sander is properly mounted on the machine.

4. Each retaining bar holds two 4½" x 6" pieces of sandpaper. Loosen the two screws securing the retaining bar, then pull the old sandpaper pieces away.
5. Cut two new pieces of sandpaper from the selected grit, then slip them under the retaining bar so that the abrasive side faces away from the center of the flap sander, as shown in **Figure 21**.

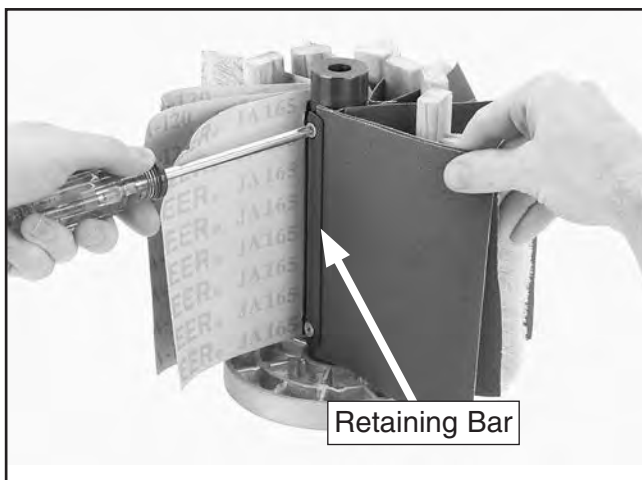

Figure 21. Replacing flap sandpaper.

6. Make sure the sandpaper pieces are even with one another and are centered in the retaining bar, then re-tighten the retaining bar screws to hold them in place.
7. If a flap brush is worn out or damaged, replace it with a new one. Insert each brush into the lower end plate and between two sandpaper pieces attached to the same retaining bar, as shown in **Figure 22**.

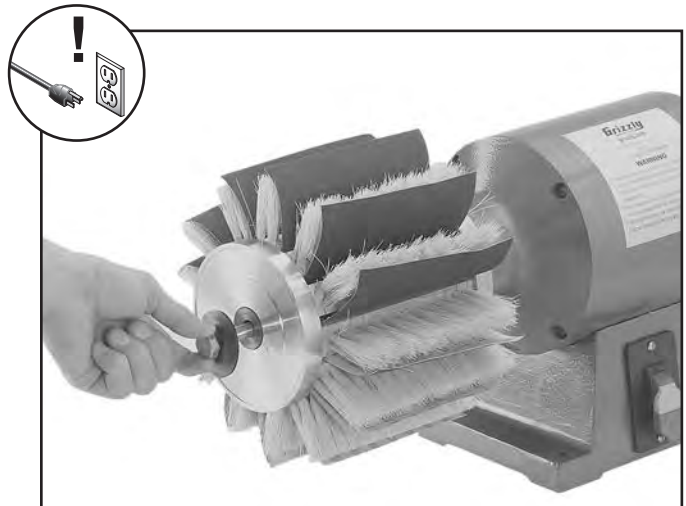

Figure 22. Sandpaper and brushes properly configured on the flap sander.

8. After replacing the sandpaper and positioning the brushes, place the top end plate onto the flap sander.
9. As you lightly push down on the top plate, correctly position one brush to align with the recessed slot in the top plate, then rotate the flap sander and work on the one next to it. Continue this process until all of the brushes are correctly aligned and fully seated into the top plate.

Note: When storing the flap sander in a dry, protected place, secure the bottom and top end plates with tie wraps or string so that the end plates do not come loose and allow the brushes to fall out.



SECTION 7: SERVICE

Review the troubleshooting and procedures in this section to fix or adjust your machine if a problem develops. If you need replacement parts or you are unsure of your repair skills, then feel free to call our Technical Support at (570) 546-9663.

Troubleshooting



Motor & Electrical

Symptom	Possible Cause	Possible Solution
Machine does not start or a breaker trips.	<ol style="list-style-type: none"> 1. Switch disabling key removed. 2. Power supply switched OFF or at fault. 3. Plug/receptacle at fault/wired wrong. 4. Start capacitor at fault. 5. Motor connection wired wrong. 6. Wall circuit breaker tripped. 7. Wiring open/has high resistance. 8. Motor ON/OFF switch at fault. 9. Motor at fault. 	<ol style="list-style-type: none"> 1. Install switch disabling key. 2. Ensure power supply is ON/has correct voltage. 3. Test for good contacts; correct the wiring. 4. Test/replace if faulty. 5. Correct motor wiring connections (Page 23). 6. Ensure circuit size is correct/replace weak breaker. 7. Check/fix broken, disconnected, or corroded wires. 8. Replace switch. 9. Test/repair/replace.
Machine stalls or is underpowered.	<ol style="list-style-type: none"> 1. Workpiece material not suitable for machine. 2. Motor wired incorrectly. 3. Plug/receptacle at fault. 4. Motor bearings at fault. 5. Machine undersized for task. 6. Motor overheated. 7. Motor at fault. 	<ol style="list-style-type: none"> 1. Only cut wood; ensure moisture is below 20%. 2. Wire motor correctly (Page 23). 3. Test for good contacts/correct wiring. 4. Test/repair/replace. 5. Clean/replace sandpaper; reduce feed rate/sanding depth. 6. Clean motor, let cool, and reduce workload. 7. Test/repair/replace.
Machine has vibration or noisy operation.	<ol style="list-style-type: none"> 1. Motor or component loose. 2. Incorrectly mounted to workbench. 3. Motor mount bolts loose/broken. 4. Motor bearings at fault. 	<ol style="list-style-type: none"> 1. Inspect/replace damaged bolts/nuts, and re-tighten with thread locking fluid. 2. Shim/tighten mounting hardware. 3. Tighten/replace. 4. Test by rotating shaft; rotational grinding/loose shaft requires bearing replacement.



Operation

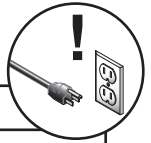

Symptom	Possible Cause	Possible Solution
Deep sanding groove or scars in workpiece.	<ol style="list-style-type: none"> 1. Sandpaper grit too coarse. 2. Workpiece sanded across grain. 3. Workpiece pressure against sanding abrasive too great. 4. Workpiece held too still against sanding abrasive. 	<ol style="list-style-type: none"> 1. Use finer grit sandpaper. 2. Sand with the grain. 3. Reduce pressure applied to the workpiece against the sanding abrasive. 4. Continuously move workpiece back-and-forth across the sanding abrasive surface.
Abrasive grain rubs off the sandpaper.	<ol style="list-style-type: none"> 1. Sandpaper has been stored in an incorrect environment. 2. Sandpaper has been folded or smashed. 	<ol style="list-style-type: none"> 1. Store sandpaper products away from extremely cold or hot temperatures and in a dry, protected location. 2. Store sanding sleeves or rolls so they are not smashed or bent; store sandpaper sheets flat.
Sanding surfaces clog quickly or burn.	<ol style="list-style-type: none"> 1. Workpiece pressure against sanding abrasive too great. 2. Sanding softwood or stock with high residue. 	<ol style="list-style-type: none"> 1. Reduce pressure applied to the workpiece against the sanding abrasive. 2. Use different stock or accept the characteristics of the stock and plan on cleaning/replacing sandpaper frequently.
Burn marks on workpiece.	<ol style="list-style-type: none"> 1. Sandpaper grit too fine. 2. Workpiece pressure against sanding abrasive too great. 3. Workpiece held too still against sanding abrasive. 	<ol style="list-style-type: none"> 1. Use coarser grit sandpaper. 2. Reduce pressure applied to the workpiece against the sanding abrasive. 3. Continuously move workpiece back-and-forth across the sanding abrasive surface.
Glazed surface on workpiece.	<ol style="list-style-type: none"> 1. Sanding wet stock. 2. Sanding stock with high residue. 	<ol style="list-style-type: none"> 1. Properly dry stock before sanding so moisture content is less than 20%. 2. Use different stock or accept the characteristics of the stock and plan on cleaning/replacing sandpaper frequently.
W o r k p i e c e frequently pulled out of your hands.	<ol style="list-style-type: none"> 1. Workpiece not correctly supported. 2. Engaging workpiece with the sander on a leading corner. 3. Starting sander with workpiece against sandpaper. 	<ol style="list-style-type: none"> 1. Hold workpiece firmly with both hands and engage with sander slowly; use additional holding/supporting devices for larger workpieces. 2. Start sanding workpiece on a trailing corner. 3. Start sander before engaging it with the workpiece.



SECTION 8: WIRING

These pages are current at the time of printing. However, in the spirit of improvement, we may make changes to the electrical systems of future machines. Study this section carefully. If there are differences between your machine and what is shown in this section, call Technical Support at (570) 546-9663 for assistance BEFORE making any changes to the wiring on your machine.

WARNING















Wiring Safety Instructions

- 1. SHOCK HAZARD.** Working on wiring that is connected to a power source is extremely dangerous. Touching electrified parts will result in personal injury including but not limited to severe burns, electrocution, or death. Disconnect the power from the machine before servicing electrical components!
- 2. QUALIFIED ELECTRICIAN.** Due to the inherent hazards of electricity, only a qualified electrician should perform wiring tasks on this machine. If you are not a qualified electrician, get help from one before attempting any kind of wiring job.
- 3. WIRE CONNECTIONS.** All connections must be tight to prevent wires from loosening during machine operation. Double-check all wires disconnected or connected during any wiring task to ensure tight connections.
- 4. MOTOR WIRING.** The motor wiring shown in these diagrams is current at the time of printing, but it may not match your machine. Always use the wiring diagram inside the motor junction box.
- 5. MODIFICATIONS.** Using aftermarket parts or modifying the wiring beyond what is shown in the diagram may lead to unpredictable results, including serious injury or fire.
- 6. WIRE/COMPONENT DAMAGE.** Damaged wires or components increase the risk of serious personal injury, fire, or machine damage. If you notice that any wires or components are damaged while performing a wiring task, replace those wires or components before completing the task.
- 7. CAPACITORS.** Some capacitors store an electrical charge for up to five minutes after being disconnected from the power source. To avoid being shocked, wait at least this long before working on capacitors.
- 8. CIRCUIT REQUIREMENTS.** You MUST follow the requirements on **Page 8** when connecting your machine to a power source.
- 9. EXPERIENCING DIFFICULTIES.** If you are experiencing difficulties understanding the information included in this section, contact our Technical Support at (570) 546-9663.

NOTICE

The photos and diagrams included in this section are best viewed in color. You can view these pages in color at www.grizzly.com.

COLOR KEY

BLACK		BLUE		YELLOW		LIGHT BLUE	
WHITE		BROWN		YELLOW GREEN		BLUE WHITE	
GREEN		GRAY		PURPLE		TURQUOISE	
RED		ORANGE		PINK			



Wiring Diagram

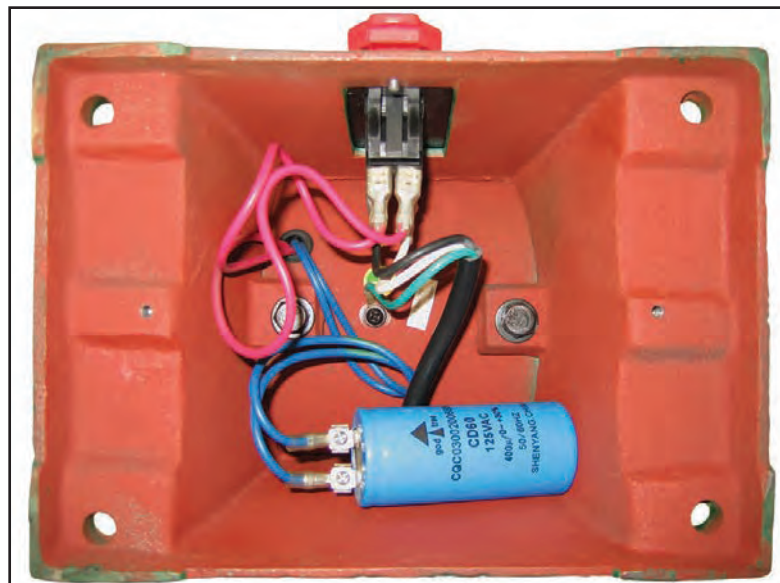
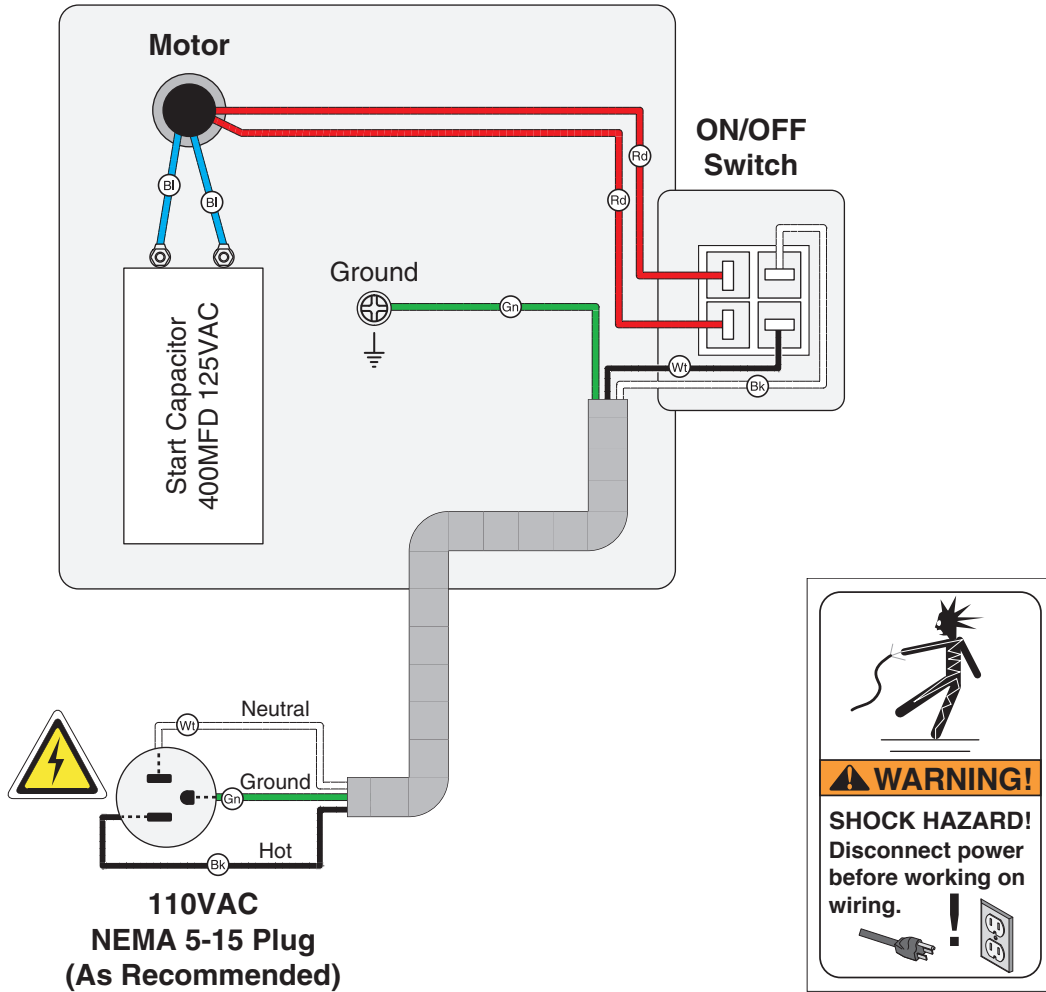
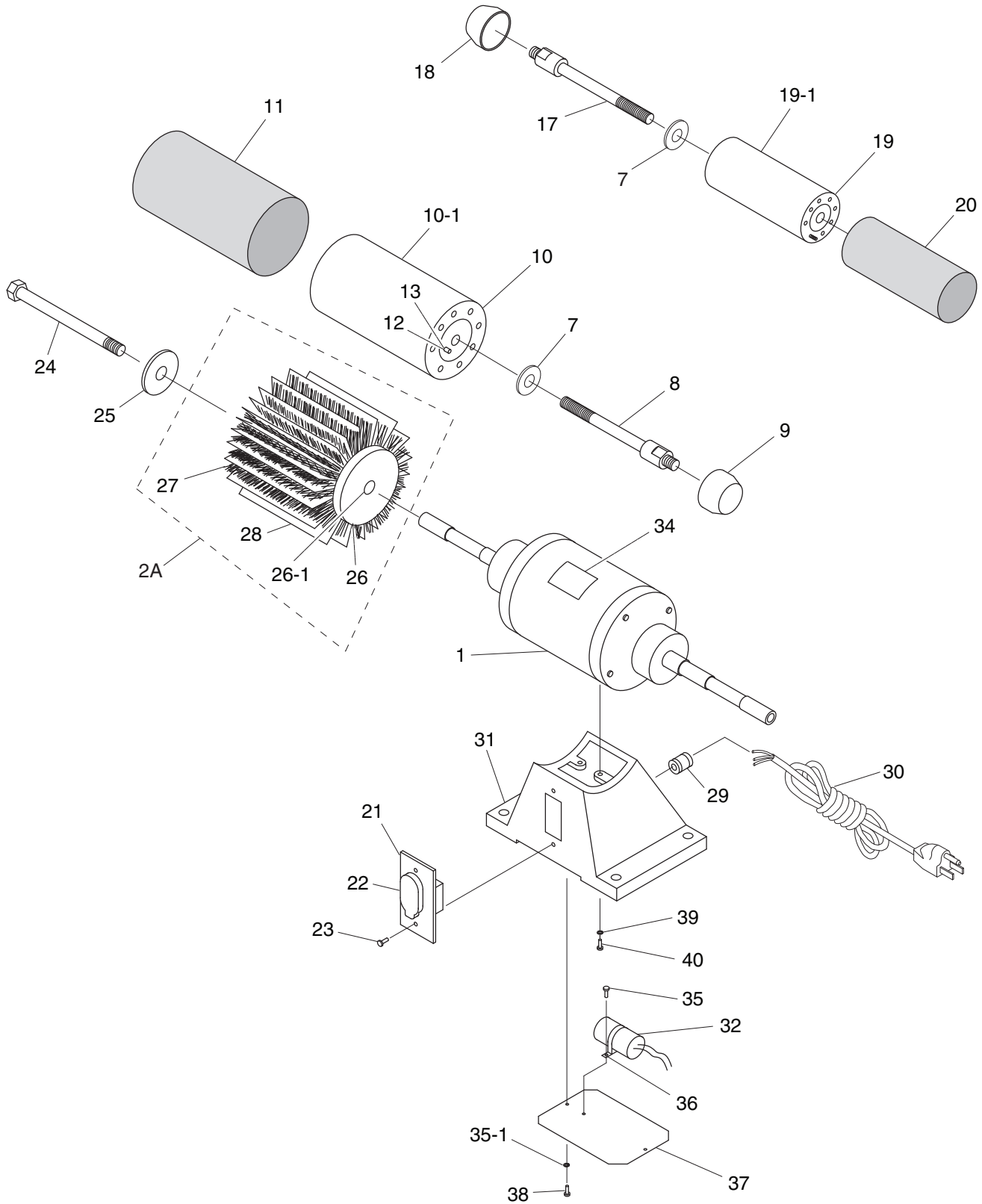

Figure 23. Model G8749 wiring.

SECTION 9: PARTS

Parts Breakdown



Parts List

REF	PART #	DESCRIPTION
1	P8749001	MOTOR 1HP 110V 60HZ
2A	P8749002A	COMPLETE FLAP SANDER ASSY
7	PW07	FLAT WASHER 5/16
8	P8749008	ARBOR BOLT RH M12-1.75 X 22
9	P8749009	END CAP RH
10	P8749010	SANDING DRUM ASSY 4-3/4 X 8
10-1	P8749010-1	DRUM BLADDER 4-3/4 X 8
11	G9211	SANDING SLEEVE 4-3/4 X 8 120G
12	P8749012	AIR VALVE
13	P8749013	VALVE CAP
17	P8749017	ARBOR BOLT LH M12-1.75 X 22
18	P8749018	END CAP LH
19	P8749019	SANDING DRUM ASSY 3-1/4 X 8
19-1	P8749019-1	DRUM BLADDER 3-1/2 X 8
20	G9199	SANDING SLEEVE 3-1/4 X 8
21	P8749021	SWITCH MOUNTING PLATE
22	PSW06	PADDLE SWITCH 110V WITH KEY
23	PS38M	PHLP HD SCR M4-.7 X 10

REF	PART #	DESCRIPTION
24	P8749024	LOCK BOLT M12-1.75 X 135 LH
25	P8749025	FLANGE WASHER 30MM
26	P8749026	FLAP SANDER END CAP
26-1	P8749026-1	FLAP SANDER SHAFT
27	P8749027	BRUSH
28	P8749028	SANDPAPER 4-1/2 X 6 120 GRIT
29	P8749029	STRAIN RELIEF
30	PWRCRD100L	POWER CORD 110V W/5-15 PLUG
31	P8749031	BASE
32	P8749032	S CAPACITOR 400M 125V 3 X 1-3/8
34	P8749034	MACHINE ID LABEL
35	PS07M	PHLP HD SCR M4-.7 X 8
35-1	PW05M	FLAT WASHER 4MM
36	P8749036	CAPACITOR BRACKET
37	P8749037	COVER PLATE
38	PS07M	PHLP HD SCR M4-.7 X 8
39	PW01M	FLAT WASHER 8MM
40	PB26M	HEX BOLT M8-1.25 X 30







WARRANTY CARD

Name _____
 Street _____
 City _____ State _____ Zip _____
 Phone # _____ Email _____
 Model # _____ Order # _____ Serial # _____

The following information is given on a voluntary basis. It will be used for marketing purposes to help us develop better products and services. **Of course, all information is strictly confidential.**

1. How did you learn about us?

Advertisement Friend Catalog
 Card Deck Website Other:

2. Which of the following magazines do you subscribe to?

<input type="checkbox"/> Cabinetmaker & FDM	<input type="checkbox"/> Popular Science	<input type="checkbox"/> Wooden Boat
<input type="checkbox"/> Family Handyman	<input type="checkbox"/> Popular Woodworking	<input type="checkbox"/> Woodshop News
<input type="checkbox"/> Hand Loader	<input type="checkbox"/> Precision Shooter	<input type="checkbox"/> Woodsmith
<input type="checkbox"/> Handy	<input type="checkbox"/> Projects in Metal	<input type="checkbox"/> Woodwork
<input type="checkbox"/> Home Shop Machinist	<input type="checkbox"/> RC Modeler	<input type="checkbox"/> Woodworker West
<input type="checkbox"/> Journal of Light Cont.	<input type="checkbox"/> Rifle	<input type="checkbox"/> Woodworker's Journal
<input type="checkbox"/> Live Steam	<input type="checkbox"/> Shop Notes	<input type="checkbox"/> Other:
<input type="checkbox"/> Model Airplane News	<input type="checkbox"/> Shotgun News	
<input type="checkbox"/> Old House Journal	<input type="checkbox"/> Today's Homeowner	
<input type="checkbox"/> Popular Mechanics	<input type="checkbox"/> Wood	

3. What is your annual household income?

\$20,000-\$29,000 \$30,000-\$39,000 \$40,000-\$49,000
 \$50,000-\$59,000 \$60,000-\$69,000 \$70,000+

4. What is your age group?

20-29 30-39 40-49
 50-59 60-69 70+

5. How long have you been a woodworker/metalworker?

0-2 Years 2-8 Years 8-20 Years 20+ Years

6. How many of your machines or tools are Grizzly?

0-2 3-5 6-9 10+

7. Do you think your machine represents a good value? Yes No

8. Would you recommend Grizzly Industrial to a friend? Yes No

9. Would you allow us to use your name as a reference for Grizzly customers in your area?
Note: We never use names more than 3 times. Yes No

10. Comments: _____

CUT ALONG DOTTED LINE

FOLD ALONG DOTTED LINE



Place Stamp Here



GRIZZLY INDUSTRIAL, INC.
P.O. BOX 2069
BELLINGHAM, WA 98227-2069



FOLD ALONG DOTTED LINE

Send a Grizzly Catalog to a friend:

Name _____
Street _____
City _____ State _____ Zip _____

TAPE ALONG EDGES--PLEASE DO NOT STAPLE

WARRANTY AND RETURNS

Grizzly Industrial, Inc. warrants every product it sells for a period of **1 year** to the original purchaser from the date of purchase. This warranty does not apply to defects due directly or indirectly to misuse, abuse, negligence, accidents, repairs or alterations or lack of maintenance. This is Grizzly's sole written warranty and any and all warranties that may be implied by law, including any merchantability or fitness, for any particular purpose, are hereby limited to the duration of this written warranty. We do not warrant or represent that the merchandise complies with the provisions of any law or acts unless the manufacturer so warrants. In no event shall Grizzly's liability under this warranty exceed the purchase price paid for the product and any legal actions brought against Grizzly shall be tried in the State of Washington, County of Whatcom.

We shall in no event be liable for death, injuries to persons or property or for incidental, contingent, special, or consequential damages arising from the use of our products.

To take advantage of this warranty, contact us by mail or phone and give us all the details. We will then issue you a "Return Number," which must be clearly posted on the outside as well as the inside of the carton. We will not accept any item back without this number. Proof of purchase must accompany the merchandise.

The manufacturers reserve the right to change specifications at any time because they constantly strive to achieve better quality equipment. We make every effort to ensure that our products meet high quality and durability standards and we hope you never need to use this warranty.

Please feel free to write or call us if you have any questions about the machine or the manual.

Thank you again for your business and continued support. We hope to serve you again soon.

grizzly.com[®]
TOOL WEBSITE

Buy Direct and Save with Grizzly[®] – Trusted, Proven and a Great Value!
~Since 1983~

*Visit Our Website Today For
Current Specials!*

**ORDER
24 HOURS A DAY!
1-800-523-4777**

