

# *Grizzly* *Industrial, Inc.*®

## **PORTABLE BANDSAW AND STAND MODEL G8692 INSTRUCTION MANUAL**



COPYRIGHT © AUGUST 2003 BY GRIZZLY INDUSTRIAL, INC.  
**WARNING: NO PORTION OF THIS MANUAL MAY BE REPRODUCED IN ANY SHAPE  
OR FORM WITHOUT THE WRITTEN APPROVAL OF GRIZZLY INDUSTRIAL, INC.**  
PRINTED IN CHINA

#### **ONLINE MANUAL DISCLAIMER**

THE INFORMATION IN THIS MANUAL REPRESENTS THE CONFIGURATION OF THE MACHINE AS IT IS CURRENTLY BEING SHIPPED. THE MACHINE CONFIGURATION CAN CHANGE AS PRODUCT IMPROVEMENTS ARE INCORPORATED. IF YOU OWN AN EARLIER VERSION OF THE MACHINE, THIS MANUAL MAY NOT EXACTLY DEPICT YOUR MACHINE. CONTACT CUSTOMER SERVICE IF YOU HAVE ANY QUESTIONS ABOUT DIFFERENCES. PREVIOUS VERSIONS ARE NOT AVAILABLE ONLINE.

# WARNING

Some dust created by power sanding, sawing, grinding, drilling, and other construction activities contains chemicals known to the State of California to cause cancer, birth defects or other reproductive harm. Some examples of these chemicals are:

- Lead from lead-based paints.
- Crystalline silica from bricks, cement, and other masonry products.
- Arsenic and chromium from chemically treated lumber.

Your risk from these exposures varies, depending on how often you do this type of work. To reduce your exposure to these chemicals: work in a well ventilated area, and work with approved safety equipment, such as those dust masks that are specially designed to filter out microscopic particles.

# Table Of Contents

<b>SECTION 1: SAFETY</b> .....	<b>3</b>
Additional Safety for Bandsaws .....	5
<b>SECTION 2: GENERAL INFORMATION</b> .....	<b>6</b>
Commentary .....	6
<b>SECTION 3: CIRCUIT REQUIREMENTS</b> .....	<b>7</b>
110V Single Phase.....	7
<b>SECTION 4: MACHINE FEATURES</b> .....	<b>9</b>
<b>SECTION 5: SET UP</b> .....	<b>10</b>
Piece Inventory .....	10
Hardware Recognition Chart .....	11
Clean Up .....	12
Site Considerations .....	12
Rubber Feet .....	13
Installation .....	13
Portable Conversion.....	13
Blade Guide Installation .....	14
<b>SECTION 6: OPERATIONS</b> .....	<b>15</b>
Operation Safety .....	15
Machine Capacity.....	15
Switch Operation .....	15
Blade Selection .....	16
Blade Speeds.....	16
Blade Travel .....	17
Starting Bandsaw .....	17
Using Table Vise .....	19
<b>SECTION 7: MAINTENANCE</b> .....	<b>20</b>
Blade Breakage .....	20
Miscellaneous.....	20
Cleaning .....	20
Storage.....	20
Lubrication .....	21
Motor Brushes .....	21
Maintenance Log .....	22
<b>SECTION 8: REFERENCE INFO</b> .....	<b>23</b>
Aftermarket Accessories .....	23
Troubleshooting .....	24
Machine Data Sheet.....	25
Warranty and Returns .....	30

# SECTION 1: SAFETY

## WARNING

### For Your Own Safety Read Instruction Manual Before Operating This Equipment

The purpose of safety symbols is to attract your attention to possible hazardous conditions. This manual uses a series of symbols and signal words which are intended to convey the level of importance of the safety messages. The progression of symbols is described below. Remember that safety messages by themselves do not eliminate danger and are not a substitute for proper accident prevention measures.

 **DANGER** Indicates an imminently hazardous situation which, if not avoided, **WILL** result in death or serious injury.

 **WARNING** Indicates a potentially hazardous situation which, if not avoided, **COULD** result in death or serious injury.

 **CAUTION** Indicates a potentially hazardous situation which, if not avoided, **MAY** result in minor or moderate injury.

**NOTICE** This symbol is used to alert the user to useful information about proper operation of the equipment or property damage hazards.

## WARNING

### Safety Instructions For Metalworking Machines

1. **READ AND UNDERSTAND MACHINE OWNERS MANUAL FOR THE BAND SAW.**
2. **REMOVE ADJUSTING KEYS AND WRENCHES.** Form a habit of checking to see that keys and adjusting wrenches are removed from tool before turning on.
3. **KEEP WORK AREA CLEAN.** Cluttered areas and benches invite accidents.
4. **DO NOT USE IN DANGEROUS ENVIRONMENT.** DO NOT use power tools in damp or wet locations, or where any flammable or noxious fumes may exist. Keep work area well lighted.
5. **KEEP CHILDREN AND VISITORS AWAY.** All children and visitors should be kept at a safe distance from work area.
6. **MAKE WORKSHOP CHILD PROOF** with padlocks, master switches, or by removing starter keys.
7. **DO NOT FORCE TOOL.** It will do the job better and safer at the rate for which it was designed.
8. **USE RIGHT TOOL.** DO NOT force tool or attachment to do a job for which it was not designed.

# WARNING

## Safety Instructions For Metalworking Tools

9. **USE PROPER EXTENSION CORD.** Make sure your extension cord is in good condition. Conductor size should be in accordance with the chart below. The amperage rating should be listed on the motor or tool nameplate. An undersized cord will cause a drop in line voltage, resulting in power loss and overheating. Your extension cord must also contain a ground wire and plug pin. Always repair or replace extension cords if they become damaged.

Minimum Gauge for Extension Cords

AMP RATING	LENGTH		
	25ft	50ft	100ft
0-6	16	16	16
7-10	16	16	14
11-12	16	16	14
13-16	14	12	12
17-20	12	12	10
21-30	10	10	No

10. **WEAR PROPER APPAREL.** DO NOT wear loose clothing, gloves, neckties, rings, bracelets, or other jewelry which may get caught in moving parts. Non-slip footwear is recommended. Wear protective hair covering to contain long hair.
11. **ALWAYS USE SAFETY GLASSES.** Everyday eyeglasses only have impact resistant lenses, they are NOT safety glasses.
12. **SECURE WORK.** Use properly secured clamps or vises to hold work while performing the machining operation
13. **DO NOT OVER-REACH.** Keep proper footing and balance at all times.
14. **MAINTAIN TOOLS AND MACHINERY WITH CARE.** Keep tools sharp and clean for best and safest performance.
15. **USE RECOMMENDED ACCESSORIES.** Consult the owner's manual for recommended accessories. The use of improper accessories may cause risk of injury.

16. **REDUCE THE RISK OF UNINTENTIONAL STARTING.** On machines with magnetic contact starting switches there is a risk of starting if the machine is bumped or jarred. Always disconnect from power source before adjusting or servicing. Make sure switch is in OFF position before reconnecting.

17. **CHECK DAMAGED PARTS.** Before further use of the tool, a guard or other part that is damaged should be carefully checked to determine that it will operate properly and perform its intended function. Check for alignment of moving parts, binding of moving parts, breakage of parts, mounting, and any other conditions that may affect its operation. A guard or other part that is damaged should be properly repaired or replaced.

18. **NEVER LEAVE MACHINE RUNNING UNATTENDED. TURN POWER OFF.** DO NOT leave machine until it comes to a complete stop.

19. **SOME COOLANTS USED FOR MACHINING MAY CONTAIN HAZARDOUS CHEMICALS.** Read and understand all user information on the coolant container and protect yourself accordingly.

20. **NEVER OPERATE A MACHINE WHEN TIRED, OR UNDER THE INFLUENCE OF DRUGS OR ALCOHOL.** Full mental alertness is required at all times when running a machine.

## CAUTION

No list of safety guidelines can be complete. Every shop environment is different. Always consider safety first, as it applies to your individual working conditions. Use this and other machinery with caution and respect. Failure to do so could result in serious personal injury, damage to equipment or poor work results.

## **WARNING**

# **Additional Safety for Bandsaws**

- 1. DO NOT OPERATE WITH DULL OR BADLY WORN BLADES.** Dull blades require more demand on the motor and are less likely to cut precisely. Inspect blades before each use.
- 2. NEVER POSITION FINGERS OR THUMBS IN LINE WITH THE CUT.** Serious personal injury could occur.
- 3. DO NOT OPERATE THIS BANDSAW WITHOUT WHEEL GUARDS, PULLEY GUARDS, AND BLADE GUARDS IN PLACE.**
- 4. ALWAYS HAVE STOCK FIRMLY CLAMPED IN VICE BEFORE STARTING A CUT.**
- 5. LET THE MATERIAL COOL BEFORE HANDLING OR REMOVING FROM VISE.** Cut material is hot and can cause .
- 6. WHEN CUTTING MAGNESIUM NEVER USE SOLUBLE OILS OR EMULSIONS (OIL-WATER MIX).** Water will greatly intensify any accidental magnesium chip fire. See a coolant supplier for specific coolant recommendations when cutting magnesium.
- 7. STOP THE MACHINE BEFORE REMOVING THE WORKPIECE.**
- 8. MAKE ALL ADJUSTMENTS WITH THE POWER OFF.**
- 9. DISCONNECT THE MACHINE FROM THE POWER SOURCE BEFORE MAKING REPAIRS.**
- 10. ALL INSPECTIONS, ADJUSTMENTS, AND MAINTENANCE MUST BE DONE WITH THE POWER OFF** and the circuit breaker shut off. Wait for all moving parts to come to a complete stop.
- 11. MAKE SURE BLADE SPEED IS SET CORRECTLY FOR THE MATERIAL BEING CUT.**
- 12. RECHECK BLADE TENSION AFTER INITIAL CUT WHEN USING A NEW BLADE.**
- 13. IF AT ANY TIME YOU ARE EXPERIENCING DIFFICULTIES PERFORMING THE INTENDED OPERATION, STOP USING THE BANDSAW!** Then contact our service department or ask a qualified expert how the operation should be performed.
- 14. MAKE SURE BLADE IS PROPERLY TENSIONED BEFORE OPERATING MACHINE.**
- 15. HABITS – GOOD AND BAD – ARE HARD TO BREAK.** Develop good habits in your shop and safety will become second-nature to you.

## **WARNING**

Like all power tools, there is danger associated with the Model G8692. Accidents are frequently caused by lack of familiarity or failure to pay attention. Use this tool with respect and caution to lessen the possibility of operator injury. If normal safety precautions are overlooked or ignored, serious personal injury may occur.

## **CAUTION**

No list of safety guidelines can be complete. Every shop environment is different. Always consider safety first, as it applies to your individual working conditions. Use this and other machinery with caution and respect. Failure to do so could result in serious personal injury, damage to equipment, or poor work results.

# SECTION 2: GENERAL INFORMATION

---

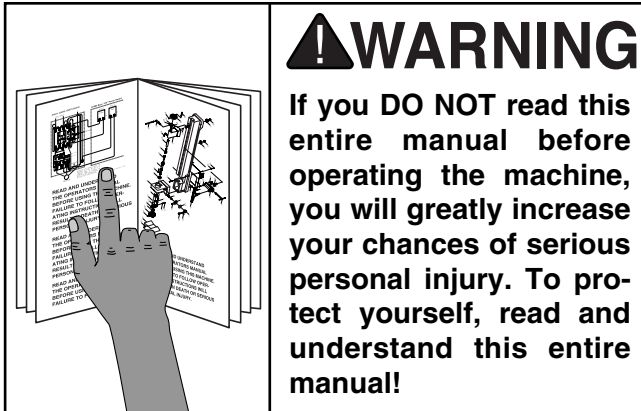

## Commentary

---

Grizzly Industrial, Inc. is proud to offer the Model G8692 Portable Bandsaw and Stand. This bandsaw is part of Grizzly's growing family of fine metalworking machinery. When used according to the guidelines stated in this manual, you can expect years of trouble-free, enjoyable operation, and proof of Grizzly's commitment to customer satisfaction.

We are also pleased to provide this manual for the Model G8692 Portable Bandsaw. It was written to guide you through assembly, review safety considerations, and cover general operating procedures. It represents our latest effort to produce the best documentation possible.

If you have any comments or criticisms that you feel we should address in our next printing, please write to us at:

Grizzly Industrial, Inc.  
% Technical Documentation  
P.O. Box 2069  
Bellingham, WA 98227

Most important, we stand behind our machines. We have excellent regional service departments at your disposal should the need arise.

If you have any service questions or parts requests, please call or write to us at the location listed below.

Grizzly Industrial, Inc  
1203 Lycoming Mall Circle  
Muncy, PA 17756  
Phone:(570) 546-9663  
Fax:(800) 438-5901  
E-Mail: [techsupport@grizzly.com](mailto:techsupport@grizzly.com)  
Web Site: <http://www.grizzly.com>

The specifications, drawings, and photographs illustrated in this manual represent the Model G8692 as supplied when the manual was prepared. However, owing to Grizzly's policy of continuous improvement, changes may be made at any time with no obligation on the part of Grizzly. For your convenience, we always keep current Grizzly manuals available on our website at [www.grizzly.com](http://www.grizzly.com). Any updates to your machine will be reflected in these manuals as soon as they are complete.



# SECTION 3: CIRCUIT REQUIREMENTS

## 110V Single Phase

### **WARNING**

Serious personal injury could occur if you connect your machine to the power source before you have completed the setup process. **DO NOT** connect the machine to the power source until instructed to do so.

### **Wiring**

The Model G8692 is wired for 110V operation.

### **Amperage Draw**

The Model G8692 has a 1 HP universal motor. The motor draws the following amps:

G8692 Motor .....12 ½ Amps

### **Circuit Breaker Requirements**

Use the following circuit breaker with your Model G8692.

Circuit Breaker .....15 Amp

### **CAUTION**

Be sure that your particular electrical configuration complies with local and state codes. The best way to ensure compliance is to check with your local municipality or a licensed electrician.



### **Your Shop Circuit Capacity**

Always check to see if the wires in your circuit are capable of handling the amperage draw from your machine, as well as any other machines that could be operating on the same circuit. If you are unsure, consult a qualified electrician.

If the circuit breaker trips or the fuse blows regularly, your machine may be operating on a circuit that is close to its amperage draw capacity. However, if an unusual amperage draw does not exist and a power failure still occurs, refer to the troubleshooting section in this manual or contact a qualified electrician or our service department.

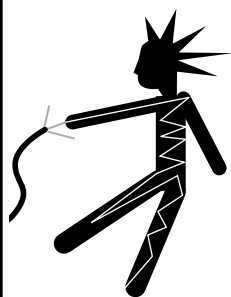

## Grounding

	<h3> <b>WARNING</b></h3> <p><b>DO NOT</b> use the machine if it is not grounded. Electrocution or fire may result if this machine is not grounded correctly. Verify that any existing electrical outlet and circuit you intend to plug into is actually grounded.</p>
--	--

In the event of a malfunction or breakdown, grounding provides electric current a path of least resistance to reduce the risk of electric shock.

This tool is equipped with an electric cord with an equipment grounding conductor. Improper connections of the electrical-grounding conductor can result in the risk of electric shock. The conductor with green or green and yellow striped insulation is the electrical grounding conductor. If repair or replacement of the electric cord or plug is necessary, do not connect the equipment grounding conductor to a live terminal.

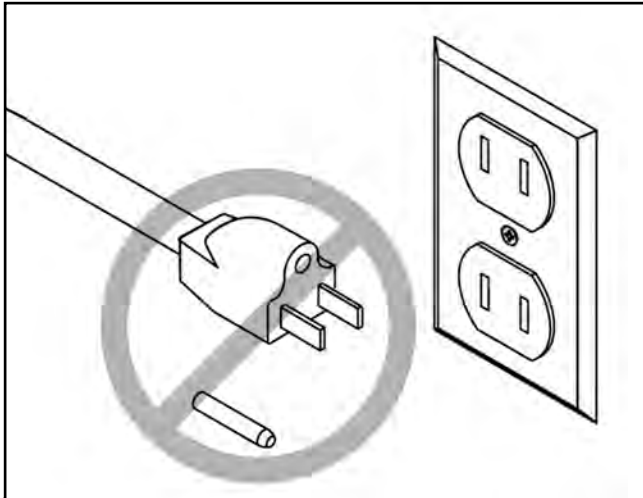

## **⚠ CAUTION**

**DO NOT remove ground prong from plug to fit into a two-pronged outlet! This machine must have a ground prong in the plug to help ensure that it is grounded. If the plug will not fit the outlet, have the proper outlet installed by a qualified electrician.**

Check with a qualified electrician or one of our service personnel if the grounding instructions are not completely understood, or if you are in doubt as to whether the tool is properly grounded.



# Extension Cords

**If you find it necessary to use an extension cord with this machine:**

- Only use a cord that is rated for standard service (Grade S).
- Only use a cord that contains a grounding prong.
- Use at least a 16 gauge cord if the cord is 50 feet long or less.
- Use at least a 14 gauge cord if the cord is between 50-100 feet.
- Always repair or replace cords when they become worn or damaged.



## **⚠ CAUTION**

**We have covered some basic electrical requirements for the safe operation of your bandsaw. These requirements are not necessarily comprehensive. You must be sure that your particular electrical configuration complies with local and state codes. Ensure compliance by checking with your local municipality or a licensed electrician.**

# SECTION 4: MACHINE FEATURES

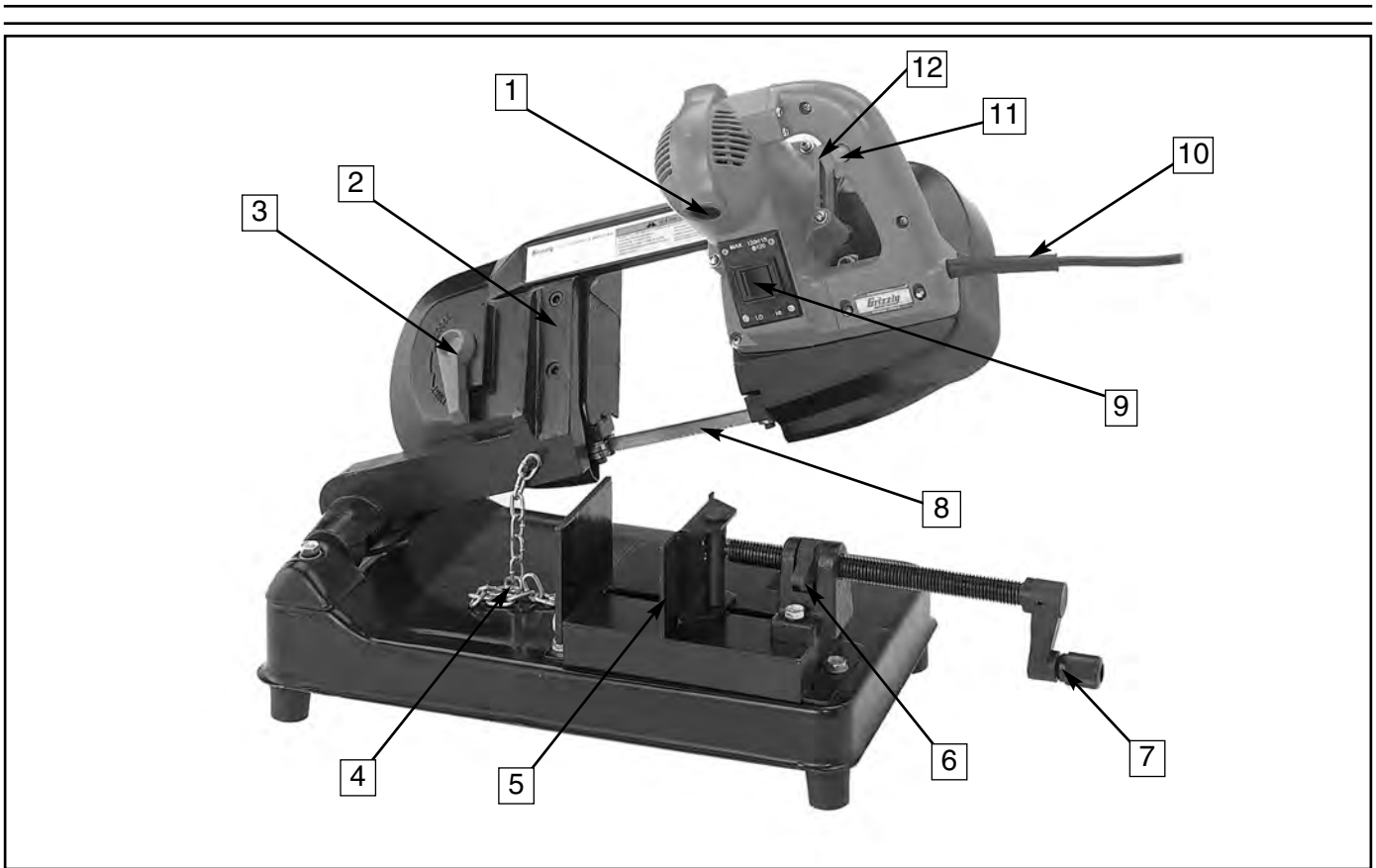

**Figure 1.** Main view of machine features and controls.

1. Motor Brush Housing
2. Work Stand Mounting Brace
3. Blade Tension Lever
4. Locking Chain
5. Vise
6. Quick Nut
7. Hand Crank
8. Blade
9. Hi/Low Speed Switch
10. Power Cord
11. Safety button
12. Trigger

# SECTION 5: SET UP

## Unpacking

The Model G8692 Portable Bandsaw was carefully packed at our warehouse. If you discover the machine is damaged after you have signed for delivery, and the truck and driver are gone, you will need to file a freight claim with the carrier. Save the containers and all packing materials for possible inspection by the carrier or its agent. Without the packing materials, filing a freight claim can be difficult. If you need assistance determining whether you need to file a freight claim, or with the procedure to file one, please contact our Customer Service.

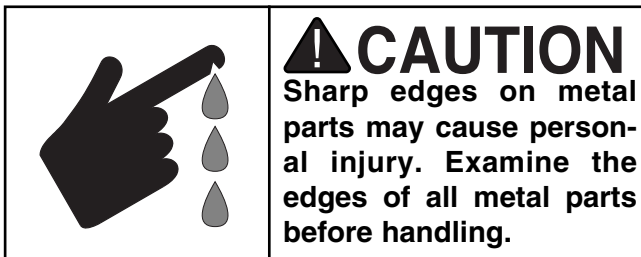

When you are completely satisfied with the condition of your shipment, you should inventory its parts.



## Piece Inventory

After all the parts have been removed from the crate, you should have:

1. Portable bandsaw (not shown)
2. Bandsaw bench stand with vise (not shown)
3. 4 Rubber work stand feet
4. Removable handle
5. 4 M6-1.0 x 25 mm Phillips head screws
6. 4 Washers 6mm
7. Hex keys 4,5,6 mm
8. Guide bar
9. 2 M5-.8 x 10mm flat-head Phillips screws
10. 2 Universal motor brushes

In the event that any non-proprietary parts are missing (e.g. nuts or washers), we would be glad to replace them, or for the sake of expediency, replacements can be obtained at your local hardware store.

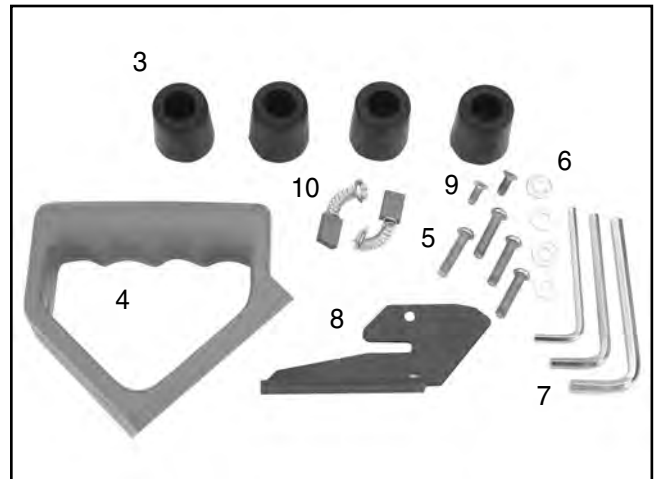









Figure 2. Piece inventory from packing box.









# Hardware Recognition Chart

USE THIS CHART TO MATCH UP  
HARDWARE DURING THE ASSEMBLY  
PROCESS!

MEASURE BOLT DIAMETER BY PLACING INSIDE CIRCLE

-  #10
-  1/4"
-  5/16"
-  3/8"
-  7/16"
-  1/2"
-  5/8"

-  4mm
-  6mm
-  8mm
-  10mm
-  12mm
-  16mm

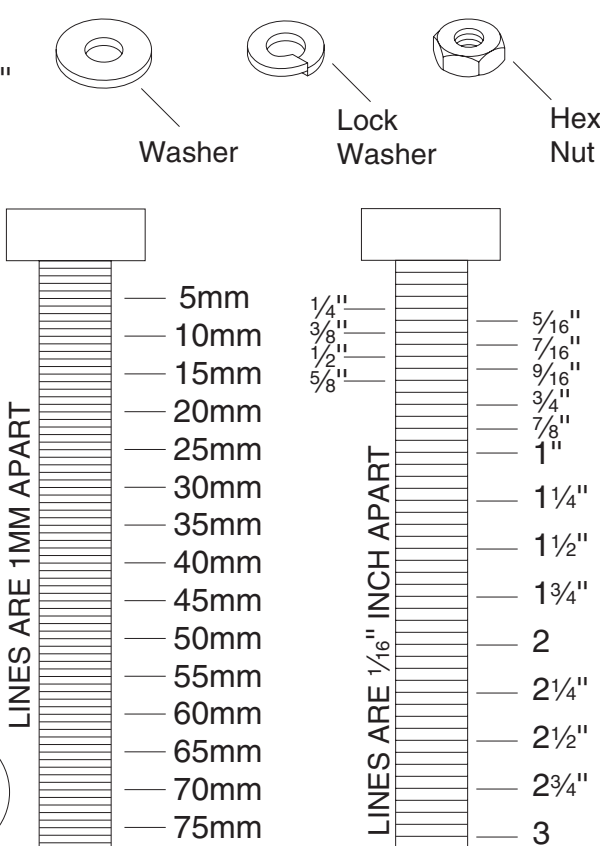
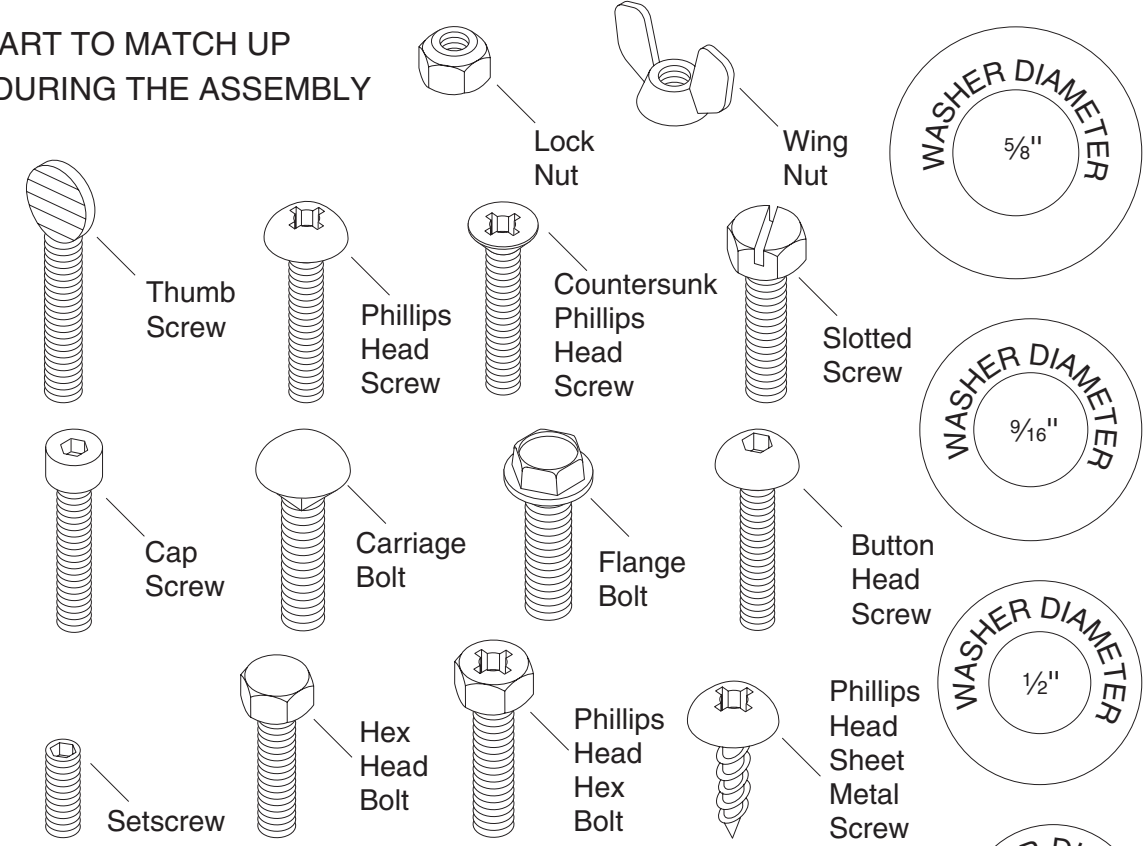

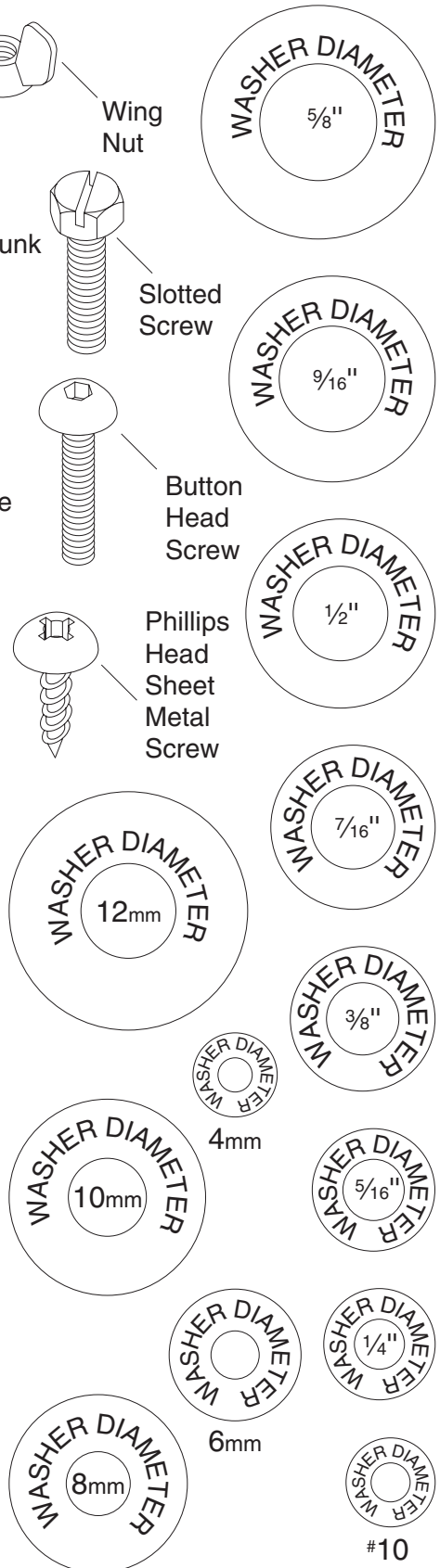

WASHERS ARE MEASURED BY THE INSIDE DIAMETER



# Clean Up

The unpainted surfaces are coated with a waxy oil to protect them from corrosion during shipment. Remove this protective coating with a solvent cleaner or citrus-based degreaser such as Grizzly's G7895 Degreaser. To clean thoroughly, some parts may need to be removed. **For optimum performance from your machine, make sure you clean all moving parts or sliding contact surfaces that are coated.** Avoid chlorine-based solvents as they may damage painted surfaces should they come in contact. Always follow the manufacturer's instructions when using any type of cleaning product.

	<b>⚠️ WARNING</b> Gasoline and petroleum products have low flash points and could cause an explosion or fire if used to clean machinery. <b>DO NOT</b> use gasoline or petroleum products to clean the machinery.
--	--

	<b>⚠️ WARNING</b> Smoking near solvents could ignite an explosion or fire and cause serious injury. <b>DO NOT</b> smoke while using solvents.
---	--

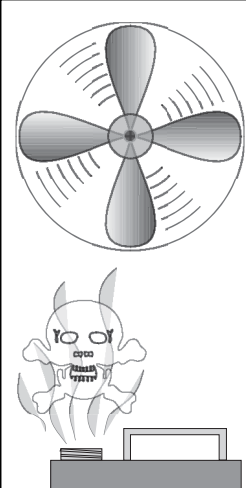
	<b>⚠️ CAUTION</b> Many of the solvents commonly used to clean machinery can be toxic when inhaled or ingested. Lack of ventilation while using these solvents could cause serious personal health risks or fire. Take precautions from this hazard by only using cleaning solvents in a well ventilated area.
---	--

# Site Considerations

- 1. Workbench Load:** The Model G8692 weighs 38 lbs and has a footprint of 10" x 18- $\frac{1}{2}$ ". Most workbenches are suitable for your machine. If you are unsure that your workbench could support the weight of the machine, additional build up to support the machine may be required.
- 2. Working Clearances:** Consider existing and anticipated needs, size of material to be processed through each machine, and space for auxiliary stands, work tables or other machinery when establishing a location for your bandsaw.
- 3. Lighting and Outlets:** Lighting should be bright enough to eliminate shadow and prevent eye strain. Electrical circuits should be dedicated or large enough to handle amperage requirements. Outlets should be located near each machine so power or extension cords are clear of high-traffic areas. Observe local electrical codes for proper installation of new lighting, outlets, or circuits.

	<b>⚠️ CAUTION</b> Unsupervised children and visitors inside your shop could cause serious personal injury to themselves. Lock all entrances to the shop when you are away and <b>DO NOT</b> allow unsupervised children or visitors in your shop at any time!
--	--



# Rubber Feet Installation

---

---

The work stand requires the installation of four rubber feet to provide a stable, slip resistant base.

## To install the rubber feet to the stand:

1. Disconnect the bandsaw from the power source.
2. Turn the bandsaw stand on its side to access the threaded holes as shown in **Figure 3**.
3. Attach the rubber feet to the guide holes in the stand with the four Phillips head screws supplied with the saw.

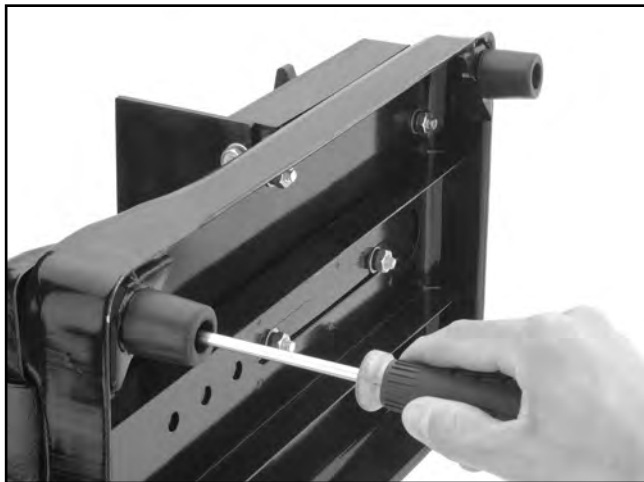

**Figure 3.** Installing the rubber feet.



# Portable Conversion

---

---

The Model G8692 can be easily converted to a portable handheld power tool.

## To convert the bandsaw for handheld use:

1. Disconnect the bandsaw from the power source.
2. Remove the bandsaw from the work stand by removing the mounting brace cap screws shown in **Figure 4**.

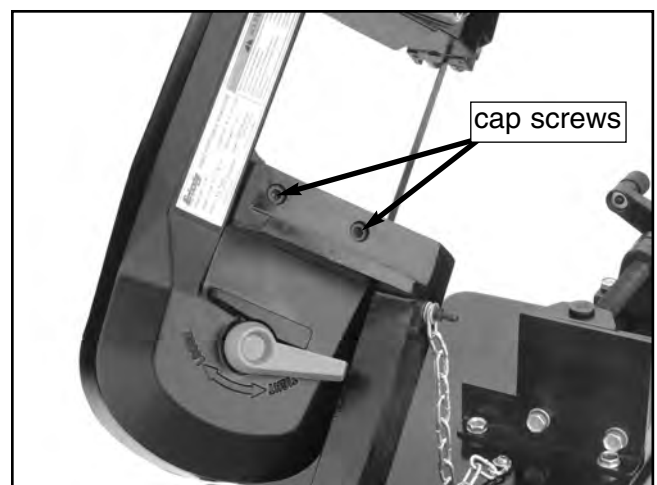

**Figure 4.** Mounting brace cap screws.

3. Install the supplied handle to the bandsaw, using the cap screws removed in **step 2**.
4. Make sure all the fasteners are tight to eliminate movement and vibration.



# Blade Guide Installation

---

To install the blade guide on your bandsaw.

1. Disconnect the bandsaw from the power source.
2. Position the blade guide over the threaded holes by the guide bearings.
3. Secure the blade guide in place with the supplied countersunk flat-head Phillips head screws as shown in **Figure 5**.

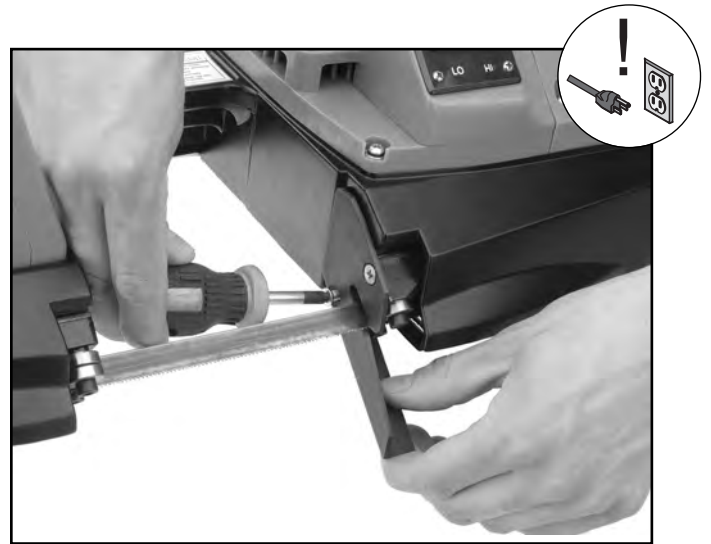

**Figure 5.** Attaching blade guide.



# SECTION 6: OPERATIONS

## Operation Safety

Your safety is important! Please follow the warnings below:

<b>⚠ WARNING</b> Damage to your eyes, lungs, and ears could result from failure to wear safety glasses, a dust mask, and hearing protection while using this machine.		
		

	<b>⚠ WARNING</b> Loose hair and clothing could get caught in machinery and cause serious personal injury. Keep loose clothing rolled up and long hair tied up and away from moving machinery.
---	--

**NOTICE**

The following section was designed to give instructions on the basic operations of this machine. However, it is in no way comprehensive of all of the machine's applications. **WE STRONGLY RECOMMEND** that you read books, trade magazines, or get formal training to maximize the potential of your machine.

## Machine Capacity

The Model G8692 is capable of cutting bar stock and steel sections to length in the horizontal position.

Maximum cutting capacity at 90°:

- G8692 (Rectangular) .....4<sup>1</sup>/<sub>2</sub>" x 4<sup>3</sup>/<sub>4</sub>"
- G8692 (Round) .....4<sup>3</sup>/<sub>4</sub>"



## Switch Operation

Press the orange button (**Figure 6**), located beside the trigger, and make sure it returns to its original position when released.

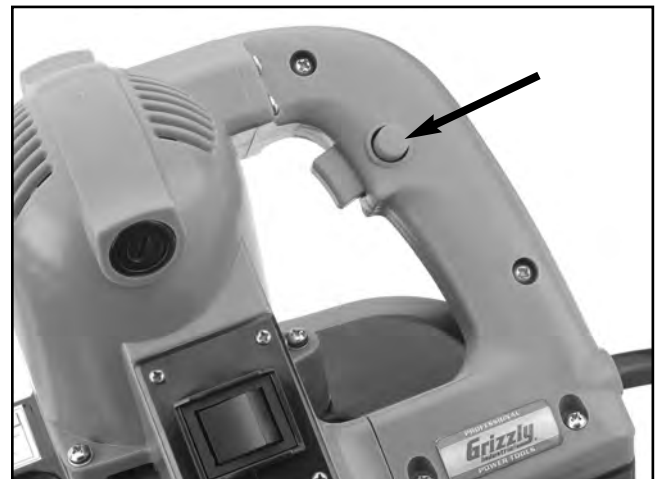

Figure 6. Orange trigger button.



---

---

# Blade Selection

Before operation, proper blade selection should be made for the type of material to be cut. The proper blade can be chosen, using a tooth per inch (tpi) rating system.

You must consider the material being cut and its diameter when choosing the correct blade. The Model G8692 comes with an 18 tpi blade which is installed.

### Blade choice based on material:

- Soft material (aluminum, lead, rubber) use a 14 tpi blade.
- Hard material (steel, cast iron) use a 24 tpi blade.
- Soft and hard material use an 18 tpi blade.

### Blade choice based on diameter:

- For thick material use a 14 tpi blade.
- For thin material use a 24 tpi blade.
- For thick or thin material use an 18 tpi blade.



---

---

# Blade Speeds

When using your bandsaw, always change to the blade speed recommended for the material to be cut. The Model G8692 has speeds of 190 feet per minute and 285 feet per minute.

## WARNING

**Never change blade speeds while the motor is running. Damage to the machine or operator could result. Let the blade stop completely before changing speeds.**

### To change the blade speed on your bandsaw:

1. Make sure the blade has completely stopped running.
2. Make sure the saw blade is NOT engaged in the workpiece.
3. Check the material you are cutting and determine the proper blade speed setting.
4. Move the blade speed control switch (**Figure 7**) to *HI* or *LO* depending on the application.

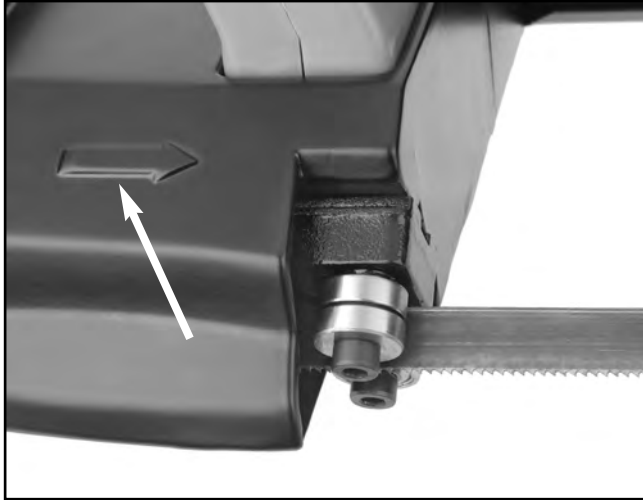

**Figure 7.** HI/LO switch.



## Blade Travel

The blade travel and wheel rotation on the Model G8692 are indicated by a direction arrow on the top cover, shown in **Figure 8**.



**Figure 8.** Blade direction.

### **WARNING**

**Always operate the bandsaw with the blade traveling in same direction as arrow. Damage to the machine, workpiece and blade will result if the blade is travelling in the opposite direction.**



## Starting Bandsaw

### **WARNING**

**Never operate the bandsaw without the proper blade guards and guides in place. Unprotected or unguided blades can cause injury to the operator and damage the machine or workpiece.**

**To start a cutting operation on the bandsaw:**

1. Make sure all guards and blade guides are in place and secure.
2. Make sure the blade is not in contact with the material.
3. Clamp the material securely in the vise if you are using the stand.
4. Connect the bandsaw to the power source.
5. Press in the orange thumb button and pull the trigger to start the bandsaw.
6. Begin the cut by slowly letting the head down onto the workpiece. **DO NOT DROP OR FORCE BLADE THROUGH THE MATERIAL.**
7. When the cut has been completed, release the trigger and let the saw come to a complete stop before removing the workpiece from the vise.

### **WARNING**

**NEVER place fingers or hands in the line of cut. In the event that something unexpected happens, your hands or fingers may be pulled into the blade. Failure to follow these warnings may result in serious personal injury!**

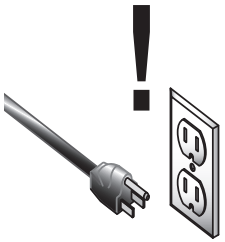

# Blade Changes

	<b>! WARNING</b> Always disconnect power to the machine when changing blades. Failure to do this may result in serious personal injury.
---	--

To remove the blade:

1. Unplug the bandsaw from the power source!
2. Remove the bandsaw from the work stand.
3. Release tension on the blade by turning the tension control handle to “loose” (Figure 9).
4. Turn the bandsaw over and unscrew the Phillips head screws to remove the back cover.

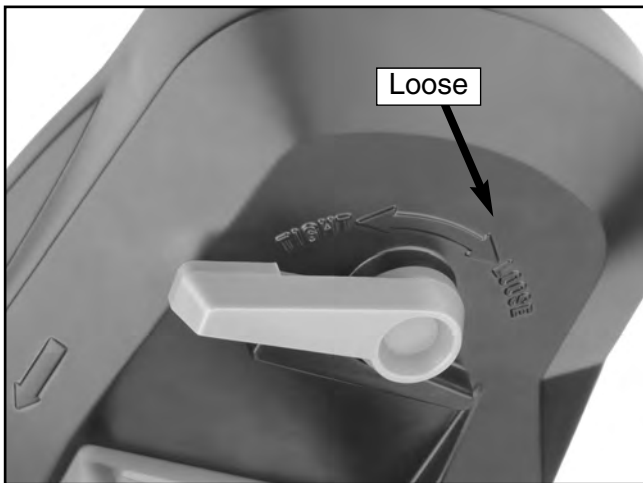

Figure 9. Tension knob.

<b>! CAUTION</b> Wear gloves and safety goggles when handling blades. Coiled blades spring open as they are uncoiled and could cause deep punctures or lacerations.
--

5. Remove the outer blade guide bearings by removing the cap screws shown in Figure 10.
6. Open the wheel covers and slide the blade off one wheel at a time. Use caution — the blade is sharp!

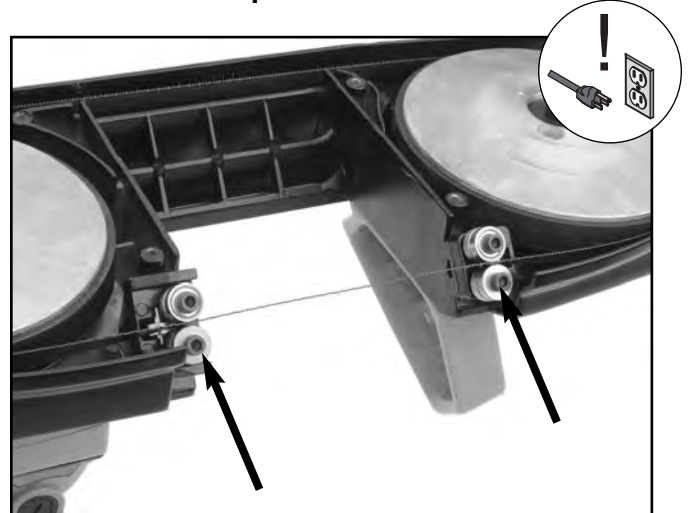

Figure 10. Blade guide bearings.

7. Place one end of the new blade over the drive pulley of the bandsaw (Figure 11).

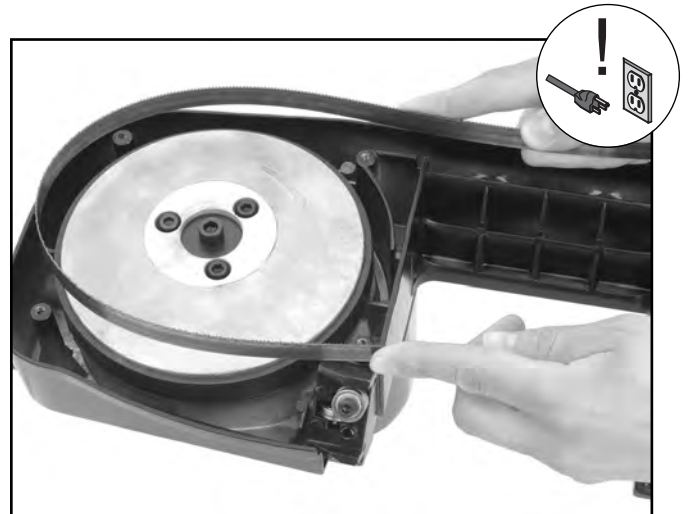
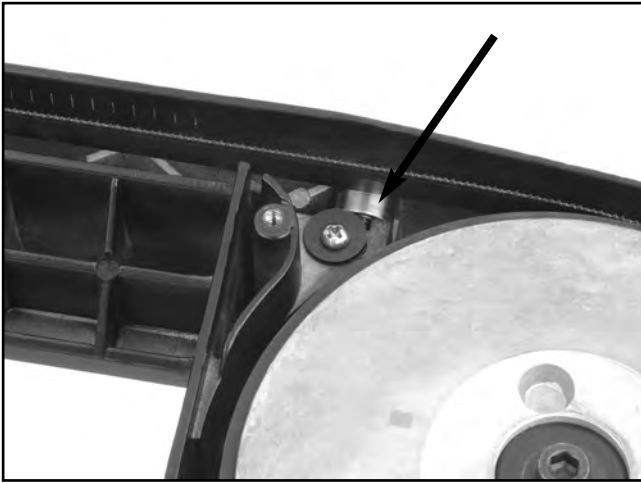

Figure 11. Installing blade.

8. Feed the other end of the blade around the idle pulley and roll the blade onto the track.
9. Make sure the back of the blade is in contact with the guide bearings that support the back of the blade (Figure 12).



**Figure 12.** Rear blade guide bearing.

10. Secure the blade guide bearings removed in **step 5**.
11. Replace the back cover of the bandsaw.
12. Turn the blade tension lever back to *"TIGHT."*



## Using Table Vise

### To use the vise on your bandsaw table:

1. Disconnect the bandsaw from the power source.
2. Secure the bandsaw to the stand before inserting the material to cut. Combine the vise can operate in two different ways, depending on how the quick nut is positioned.

- When the quick nut pointer is positioned to the left, the vise jaw can slide rapidly up to the material (**Figure 13**).

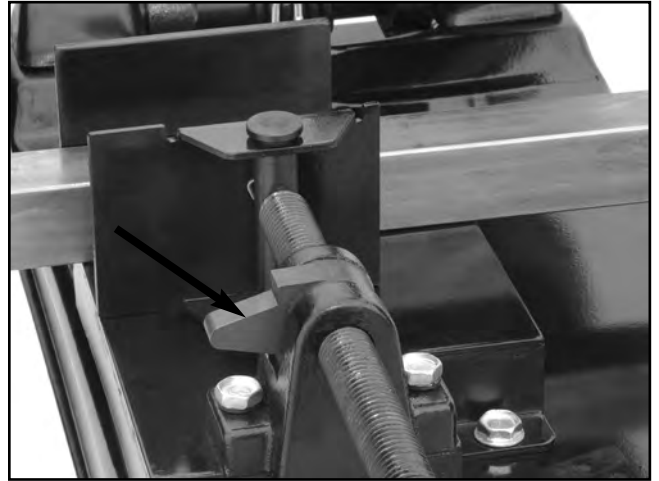

**Figure 13.** Quick nut.

- When the quick nut pointer is positioned to the right the vise jaw will move when the crank is turned for fine adjustment and clamping force (**Figure 14**).



**Figure 14.** Vise nut.

3. When the vise has secured the workpiece properly, connect the machine to the power source.



# SECTION 7: MAINTENANCE

---

---

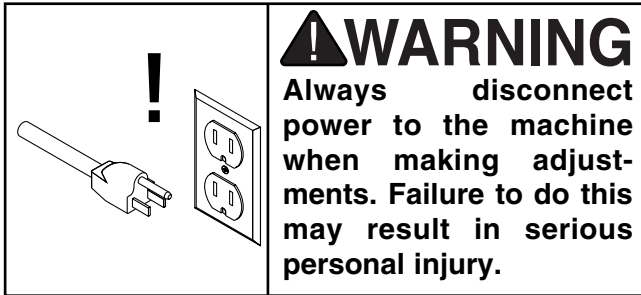

## Blade Breakage

---

---

Blade breakage is unavoidable, in some cases, as a natural result of the peculiar stresses placed on bandsaw blades. Avoidable breakage is most often the result of poor care or judgement on the part of the operator when mounting or adjusting the blade or support guides.

**The most common causes of blade breakage are:**

- Faulty alignment or adjustment of the guides
- Using a blade with a lumpy or improperly finished braze or weld
- Feeding the workpiece too fast
- Tooth dullness or absence of sufficient set
- Excessive or too little blade tension
- Running the bandsaw excessively when not resawing
- Not releasing blade tension after use



## Miscellaneous

---

---

Always be aware of the condition of your machine. Routinely check for the following conditions and repair or replace as necessary:

- Loose mounting bolts
- Worn switch
- Worn or damaged blade
- Dirt or oil build up
- Worn or damaged support bearings or guide bearings



## Cleaning

---

---

Cleaning your machine will extend its life and produce better results.

Important places of the Model G8692 to keep clean are the motor area, the blade, and the stand. Make sure these areas are free from oil and debris.



## Storage

---

---

When storing the bandsaw for long periods of time, it is important to perform the following:

- Release tension on the blade.
- Store bandsaw in a safe dry place.



# Lubrication

---

---

No lubrication is required for the Model G8692. All of the bearings in this machine have been lubricated with a sufficient amount of high grade lubricant. This lubricant will last for the life of the machine under normal operating conditions.



## Motor Brushes

---

---

The Model G8692 comes with 2 extra motor brushes to help prolong the life of the universal motor.

### To change the motor brushes:

1. Use a flat-head screw driver to remove the motor brush covers as shown in **Figure 15**.

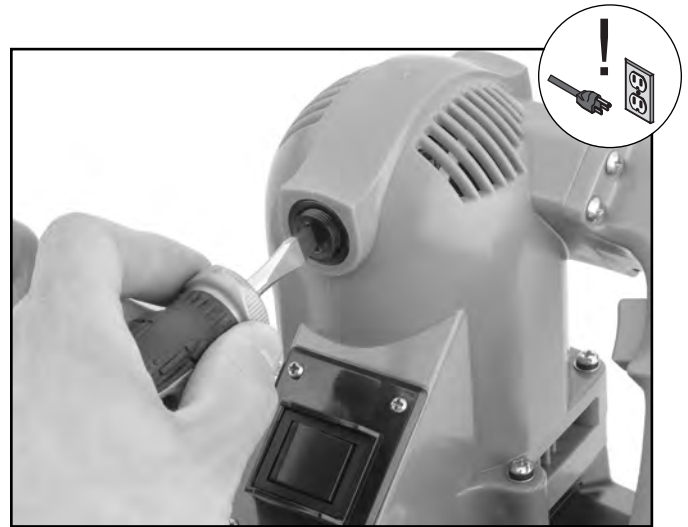

**Figure 15.** Motor brush removal.

2. Remove the motor brushes.
3. Clean or replace the motor brushes and secure the covers.





# SECTION 8: REFERENCE INFO

---

The following pages contain aftermarket accessories information, the machine data sheet, parts diagrams, parts lists, wiring diagrams, troubleshooting information and Warranty/Return information for your Model G8692.

If you need parts or help in assembling your machine, or if you need operational information, call the Grizzly Service Department. Trained service technicians will be glad to help you.

If you have any comments regarding this manual, please write to Grizzly at the address below:

Grizzly Industrial, Inc.  
% Technical Documentation  
P.O. Box 2069  
Bellingham, WA 98227-2069

We recommend you keep a copy of our current catalog for complete information regarding Grizzly's warranty and return policy. If you need additional technical information relating to this machine, or if you need general assistance or replacement parts, please contact the Service Department at the location listed below.

Grizzly Industrial, Inc.  
1203 Lycoming Mall Circle  
Muncy, PA 17756  
Phone: (570) 546-9663  
Fax: (800) 438-5901  
E-Mail: [techsupport@grizzly.com](mailto:techsupport@grizzly.com)  
Web Site: <http://www.grizzly.com>



## Aftermarket Accessories

---

### Tool steel bandsaw blades:

<u>MODEL</u>	<u>TYPE</u>	<u>WIDTH</u>	<u>GAUGE</u>	<u>TPI</u>
G9112	Raker	1/2"	0.025	14
G9113	Raker	1/2"	0.025	18
G9114	Raker	1/2"	0.025	24

### Bi-Metal Variable Pitch Bandsaw Blades

<u>MODEL</u>	<u>TYPE</u>	<u>WIDTH</u>	<u>GAUGE</u>	<u>TPI</u>
G9115	VP	1/2"	0.025	10-14
G9116	VP	1/2"	0.025	14-18
G9117	VP	1/2"	0.025	20-24



# Troubleshooting

Motor will not start.	<ol style="list-style-type: none"> <li>1. Low voltage.</li> <li>2. Open circuit in motor or loose connections.</li> </ol>	<ol style="list-style-type: none"> <li>1. Check power line for proper voltage.</li> <li>2. Inspect all lead connections on motor for loose or open connections.</li> </ol>
Motor will not start; fuses or circuit breaker blown.	<ol style="list-style-type: none"> <li>1. Short circuit in line cord or plug.</li> <li>2. Short circuit in motor or loose connections.</li> <li>3. Circuit Overloaded.</li> </ol>	<ol style="list-style-type: none"> <li>1. Repair or replace cord or plug for damaged insulation and shorted wires.</li> <li>2. Repair or replace all connections on motor for loose or shorted terminals or worn insulation.</li> <li>3. Reduce load on circuit.</li> </ol>
Motor fails to develop full power (power output of motor decreases rapidly with decrease in voltage at motor terminals).	<ol style="list-style-type: none"> <li>1. Power line overloaded with lights, appliances, and other motors.</li> <li>2. Undersized wires or circuits too long.</li> <li>3. General overloading of power company facilities.</li> </ol>	<ol style="list-style-type: none"> <li>1. Reduce load on power line.</li> <li>2. Increase wire sizes or reduce length of wire.</li> <li>3. Request a power check from the power company.</li> </ol>
Motor overheats.	<ol style="list-style-type: none"> <li>1. Motor overloaded.</li> <li>2. Air circulation through the motor restricted.</li> </ol>	<ol style="list-style-type: none"> <li>1. Reduce load on motor.</li> <li>2. Clean out motor to provide normal air circulation.</li> </ol>
Motor stalls (resulting in blown fuses or tripped circuit).	<ol style="list-style-type: none"> <li>1. Short circuit in motor or loose connections.</li> <li>2. Low voltage.</li> <li>3. Incorrect fuses or circuit breaker in power line.</li> <li>4. Motor overloaded.</li> </ol>	<ol style="list-style-type: none"> <li>1. Repair or replace connections on motor for loose or shorted terminals or worn insulation.</li> <li>2. Correct the low voltage conditions.</li> <li>3. Install correct fuses or circuit breaker.</li> <li>4. Reduce load on motor.</li> </ol>
Machine slows when operating.	Applying too much pressure to workpiece.	Feed workpiece slower.
Blade does not run evenly on wheels.	<ol style="list-style-type: none"> <li>1. Blade support bearings set incorrectly.</li> <li>2. Wheels are not coplanar.</li> </ol>	<ol style="list-style-type: none"> <li>1. Adjust blade support bearings.</li> <li>2. Call Grizzly Service Department (570) 546-9663.</li> </ol>
Blade does not cut evenly.	<ol style="list-style-type: none"> <li>1. Blade is not properly tensioned.</li> <li>2. Wheels are not coplanar.</li> <li>3. Tooth set is uneven.</li> <li>4. Teeth are sharper on one side than the other.</li> </ol>	<ol style="list-style-type: none"> <li>1. Adjust blade tension.</li> <li>2. Call Grizzly Service Department (570) 546-9663.</li> <li>3. Replace blade.</li> <li>4. Replace blade.</li> </ol>
Blade slows when cutting. Blade makes a squealing noise, especially on start-up.	<ol style="list-style-type: none"> <li>1. V-belt loose.</li> <li>2. V-belt worn out.</li> </ol>	<ol style="list-style-type: none"> <li>1. Tighten V-belt.</li> <li>2. Replace V-belt.</li> </ol>
Ticking sound when the saw is running.	Weld contacting guide blocks or support bearing.	Use the Model G2516 Stone to smooth the blade weld.



# MACHINE DATA SHEET

Customer Service #: (570) 546-9663 · To Order Call: (800) 523-4777 · Fax #: (800) 438-5901

## MODEL G8692 PORTABLE BANDSAW W/ STAND

### Product Dimensions:

Weight..... 31 lbs.  
Width (side-to-side) x Depth (front-to-back) x Height..... 18-1/2 x 13 x 14 in.  
Footprint (Length x Width)..... 10 x 18-1/2 in.

### Shipping Dimensions:

Type..... Cardboard Box  
Content..... Machine  
Weight..... 38 lbs.  
Length x Width x Height..... 16 x 24 x 13 in.

### Electrical:

Power Requirement..... 110V, Single-Phase, 60 Hz  
Prewired Voltage..... 110V  
Full-Load Current Rating..... 3A  
Minimum Circuit Size..... 15A  
Connection Type..... Cord & Plug  
Power Cord Included..... Yes  
Power Cord Length..... 5 ft.  
Power Cord Gauge..... 14 AWG  
Plug Included..... Yes  
Included Plug Type..... 1-15  
Switch Type..... Trigger Switch

### Motors:

#### Main

Type..... Universal  
Horsepower..... 1 HP  
Phase..... Single-Phase  
Amps..... 12.5A  
Bearings..... Shielded & Permanently Lubricated

### Other Specifications:

ISO 9001 Factory ..... Yes

### Features:

Includes Stand with Locking Vise  
Double Insulated



# G8692

REF	PART #	DESCRIPTION
1	PS66M	PHLP HD SCR M4-.8 X 40
2	P8692002	MOTOR HOUSING
3	P608	BALL BEARING 608Z
4	P8692004	CONNECTING RING
5	P8692005	ARMATURE
6	PSB11M	CAP SCREW M8-1.25 X 16
7	PW01M	FLAT WASHER 8MM
8	P8692008	GRIP HANDLE
9	P8692009	TENSION HANDLE
10	P8692010	FRONT BRACKET
11	P8692011	FRAME
12	P8692012	TENSION SPRING
13	P8692013	SPRING FITTING PLATE
14	PW03M	FLAT WASHER 6MM
15	PN06M	HEX NUT M5-0.8
16	P8692016	IDLE WHEEL
17	P8692017	SLEEVE BEARING
18	PW01M	FLAT WASHER 8MM
19	P8692019	WASHER FOR IDLE WHEEL
20	PSB11M	CAP SCREW M8-1.25 X 16
21	P8692021	RUBBER WHEEL
22	P8692022	BEARING WASHER
23	P8692023	FIELD ASSEMBLY
24	P8692024	BRUSH HOLDER
25	P8692025	CARBON BRUSH
26	P8692026	BRUSH CAP
27	P8692027	SPEED CHANGE SWITCH
28	P8692028	SWITCH RETAINER
29	PHTEK21	TAP SCREW M3 X 8
30	PW03M	FLAT WASHER 6MM
31	PLW01M	LOCK WASHER 5MM
32	PS54M	PHLP HD SCREW M5-.8 X 45
33	P6200	BALL BEARING 6200Z
34	P8692034	STOPPER RING M6
35	P8692035	NEEDLE BEARING HK081210
36	P8692036	STOPPER RING M6
37	P8692037	BAFFLE
38	P8692038	1ST. STAGE GEAR
39	P8692039	2ND STAGE GEAR
40	P6201	BALL BEARING 6201
41	P6200	BALL BEARING 6200Z
42	P8692042	WOODRUFF KEY 2.5-10
43	P8692043	2ND STAGE PINION
44	P8692044	WOODRUFF KEY 2.5-10
45	P8692045	SPROCKET (SMALL)
46	P608	BALL BEARING 608Z

REF	PART #	DESCRIPTION
47	P8692047	RUBBER PIN
48	P8692048	HANDLE
49	PN06M	HEX NUT M5-0.8
50	P8692050	REAR BLADE GUIDE
51	P625	BALL BEARING 625
52	P8692052	FRONT BLADE GUIDE
53	PW02M	FLAT WASHER 5MM
54	PS20M	PIN 5 X 16
55	P8692055	GUIDE ROLLER
56	P8692056	HEX HEAD SCREW M5-45
57	PFH07M	FLAT HD SCR M5-.8 X 10
58	P8692058	GUIDE BAR
59	P8692059	TOOL COVER
60	P8692060	YOKE
61	P8692061	COLLAR
62	P8692062	WASHER
63	PW03M	FLAT WASHER 6MM
64	P8692064	FIXING SHAFT
65	PFH05M	FLAT HD SCR M5-.8 X 12
66	PW02M	FLAT WASHER 5MM
67	P8692067	TAPPING SCREW ST4.8-19
68	PS69M	PHLP HD SCR M5-1 X 25
69	PS69M	PHLP HD SCR M5-1 X 25
70	PLW01M	LOCK WASHER 5MM
71	P8692071	HANDLE COVER
72	PS65M	PHLP HD SCR M4-.8 X 40
73	P8692073	FIXING PLATE
74	P8692074	CORD AND PLUG
75	P8692075	CORD GUARD
76	P8692076	POWER SUPPLY SWITCH
77	P8692077	SPROCKET WHEEL
78	P8692078	CHAIN
79	PN03M	HEX NUT M8-1.25
80	PW01M	FLAT WASHER 8MM
81	PW04M	FLAT WASHER 10MM
82	P8692082	DRIVING WHEEL SHAFT
83	P8692083	DRIVING WHEEL
84	PSB103M	CAP SCREW M8-1.25 X 65
85	PW03M	FLAT WASHER 6MM
86	PLW04M	LOCK WASHER 8MM
87	PSB07M	CAP SCREW M6-1 X 30
88	PW02M	FLAT WASHER 5MM
89	PS70M	PHLP HD SCR M5-1 X 8
90	PS71M	PHLP HD SCR M5-1 X 16
91	P8692091	NAME PLATE
92	P8692092	CONNECTING SHEET 6.3

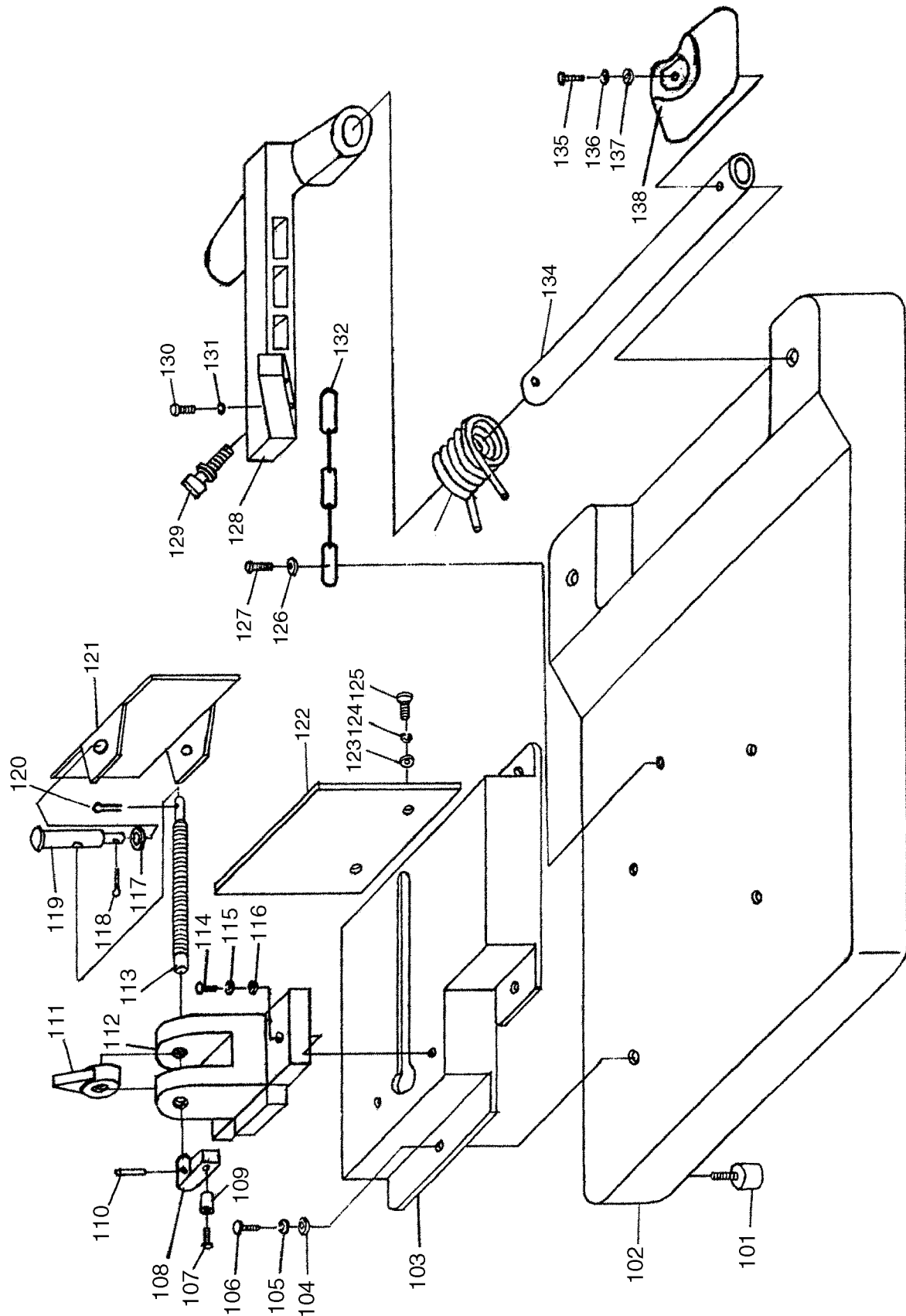

# G8692

REF	PART #	DESCRIPTION
101	P8692101	RUBBER FEET
102	P8692102	BASE
103	P8692103	WORKING TABLE
104	PW01M	FLAT WASHER 8MM
105	PLW04M	LOCK WASHER 8MM
106	PB03M	HEX BOLT M8-1.25 X 16
107	P8692107	FLAT HEAD SCREW M5-.8 x 10
108	P8692108	HANDLE
109	P8692109	KNOB
110	P8692110	PIN
111	P8692111	QUICK NUT
112	P8692112	SCREW BASE
113	P8692113	LEAD SCREW
114	PB09M	HEX BOLT M8-1.25 X 20
115	PLW04M	LOCK WASHER 8MM
116	PW01M	FLAT WASHER 8MM
117	PW01M	FLAT WASHER 8MM
118	P8692118	COTTER PIN 3 X 20
119	P8692119	FASTEN PIN
120	P8692120	PRESSING PIN
121	P8692121	PRESSING PLATE
122	P8692122	FASTEN PLATE
123	PW01M	FLAT WASHER 8MM
124	PLW04M	LOCK WASHER 8MM
125	PB03M	HEX BOLT M8-1.25 X 16
126	PW03M	FLAT WASHER 6MM
127	PS72M	PHLP HD SCR M6-1 X 12
128	P8692128	TURNING ARM
129	P8692129	CHAIN BOLT
130	PB03M	HEX BOLT M8-1.25 X 16
131	PLW04M	LOCK WASHER 8MM
132	P8692132	CHAIN
133	P8692133	SPRING
134	P8692134	PIPE
135	PB20M	HEX BOLT M8-1.25 X 35
136	PLW04M	LOCK WASHER 8MM
137	PW01M	FLAT WASHER 8MM
138	P8692138	COVER

# WARRANTY AND RETURNS

---

---

Grizzly Industrial, Inc. warrants every product it sells for a period of **1 year** to the original purchaser from the date of purchase. This warranty does not apply to defects due directly or indirectly to misuse, abuse, negligence, accidents, repairs or alterations or lack of maintenance. This is Grizzly's sole written warranty and any and all warranties that may be implied by law, including any merchantability or fitness, for any particular purpose, are hereby limited to the duration of this written warranty. We do not warrant or represent that the merchandise complies with the provisions of any law or acts unless the manufacturer so warrants. In no event shall Grizzly's liability under this warranty exceed the purchase price paid for the product and any legal actions brought against Grizzly shall be tried in the State of Washington, County of Whatcom.

We shall in no event be liable for death, injuries to persons or property or for incidental, contingent, special, or consequential damages arising from the use of our products.

To take advantage of this warranty, contact us by mail or phone and give us all the details. We will then issue you a "Return Number," which must be clearly posted on the outside as well as the inside of the carton. We will not accept any item back without this number. Proof of purchase must accompany the merchandise.

The manufacturers reserve the right to change specifications at any time because they constantly strive to achieve better quality equipment. We make every effort to ensure that our products meet high quality and durability standards and we hope you never need to use this warranty.

Please feel free to write or call us if you have any questions about the machine or the manual.

Thank you again for your business and continued support. We hope to serve you again soon.

# WARRANTY CARD

Name \_\_\_\_\_  
Street \_\_\_\_\_  
City \_\_\_\_\_ State \_\_\_\_\_ Zip \_\_\_\_\_  
Phone Number \_\_\_\_\_ E-Mail \_\_\_\_\_ FAX \_\_\_\_\_  
MODEL: \_\_\_\_\_ Serial # \_\_\_\_\_ Order \_\_\_\_\_

The following information is given on a voluntary basis. It will be used for marketing purposes to help us develop better products and services. Of course, all information is strictly confidential.

1. How did you learn about us?  
 Advertisement  Friend  
 Catalog  Card Deck  
 World Wide Web  
 Other \_\_\_\_\_
2. Which of the following magazines do you subscribe to.  
 American Woodworker  Practical Homeowner  
 Cabinetmaker  Shop Notes  
 Family Handyman  Today's Homeowner  
 Fine Homebuilding  WOOD  
 Fine Woodworking  Wooden Boat  
 Home Handyman  Woodshop News  
 Journal of Light Construction  Woodsmith  
 Old House Journal  Woodwork  
 Popular Mechanics  Woodworker  
 Popular Science  Woodworker's Journal  
 Popular Woodworking  Workbench  
 Other \_\_\_\_\_
3. Which of the following woodworking/remodeling shows do you watch?  
 Backyard America  The New Yankee Workshop  
 Home Time  This Old House  
 The American Woodworker  Woodwright's Shop  
 Other \_\_\_\_\_
4. What is your annual household income?  
 \$20,000-\$29,999  \$60,000-\$69,999  
 \$30,000-\$39,999  \$70,000-\$79,999  
 \$40,000-\$49,999  \$80,000-\$89,999  
 \$50,000-\$59,999  \$90,000 +
5. What is your age group?  
 20-29  50-59  
 30-39  60-69  
 40-49  70 +
6. How long have you been a woodworker?  
 0 - 2 Years  8 - 20 Years  
 2 - 8 Years  20+ Years
7. How would you rank your woodworking skills?  
 Simple  Advanced  
 Intermediate  Master Craftsman
8. What stationary woodworking tools do you own? Check all that apply.  
 Air Compressor  Panel Saw  
 Band Saw  Planer  
 Drill Press  Power Feeder  
 Drum Sander  Radial Arm Saw  
 Dust Collector  Shaper  
 Horizontal Boring Machine  Spindle Sander  
 Jointer  Table Saw  
 Lathe  Vacuum Veneer Press  
 Mortiser  Wide Belt Sander
9. How many of your woodworking machines are Grizzly? \_\_\_\_\_  
 Other \_\_\_\_\_
10. Which benchtop tools do you own? Check all that apply.  
 1" x 42" Belt Sander  6" - 8" Grinder  
 5" - 8" Drill Press  Mini Lathe  
 8" Table Saw  10" - 12" Thickness Planer  
 8" - 10" Bandsaw  Scroll Saw  
 Disc/Belt Sander  Spindle/Belt Sander  
 Mini Jointer  
 Other \_\_\_\_\_
11. How many of the machines checked above are Grizzly? \_\_\_\_\_
12. Which portable/hand held power tools do you own? Check all that apply.  
\_\_\_\_\_  
\_\_\_\_\_  
\_\_\_\_\_
13. What machines/supplies would you like Grizzly Industrial to carry?  
\_\_\_\_\_  
\_\_\_\_\_  
\_\_\_\_\_
14. What new accessories would you like Grizzly Industrial to carry?  
 Builders Hardware  Hand Tools  
 Fasteners  Wood Components  
 Other \_\_\_\_\_
15. What other companies do you purchase your tools and supplies from?  
\_\_\_\_\_  
\_\_\_\_\_
16. Do you think your purchase represents good value?  
 Yes  No
17. Would you recommend Grizzly Industrial to a friend?  
 Yes  No
18. Would you allow us to use your name as a reference for Grizzly customers in your area? **Note: We never use names more than three times.**  
 Yes  No
19. Comments: \_\_\_\_\_  
\_\_\_\_\_  
\_\_\_\_\_  
\_\_\_\_\_

CUT ALONG DOTTED LINE

FOLD ALONG DOTTED LINE

---

---

---



Place  
Stamp  
Here



**GRIZZLY INDUSTRIAL, INC.**  
**P.O. BOX 2069**  
**BELLINGHAM, WA 98227-2069**



FOLD ALONG DOTTED LINE

Send a Grizzly Catalog to a friend:

Name _____
Street _____
City _____ State _____ Zip _____

TAPE ALONG EDGES--PLEASE DO NOT STAPLE



# grizzly.com

**TOOL WEBSITE**

Buy Direct and Save with Grizzly® – Trusted, Proven and a Great Value!

*Visit Our Website Today And Discover Why  
Grizzly® Is The Industry Leader!*

- SECURE ORDERING
- ORDERS SHIPPED WITHIN 24 HOURS
- E-MAIL RESPONSE WITHIN ONE HOUR

**plus**

Receive a

**FREE GIFT**

with each online order  
for Limited Time Only

-OR-

Call Today For A **FREE**  
Full Color Catalog

**1-800-523-4777**

